

# ECEN689: Special Topics in Optical Interconnects Circuits and Systems

## Spring 2022

---

### Lecture 2: Optical Channels



Sam Palermo

Analog & Mixed-Signal Center

Texas A&M University

# References

---

- Majority of material follows Sackinger Chapter 2
- I also refer to some excellent fiber optic tutorials on the web

# High-Speed Optical Link System

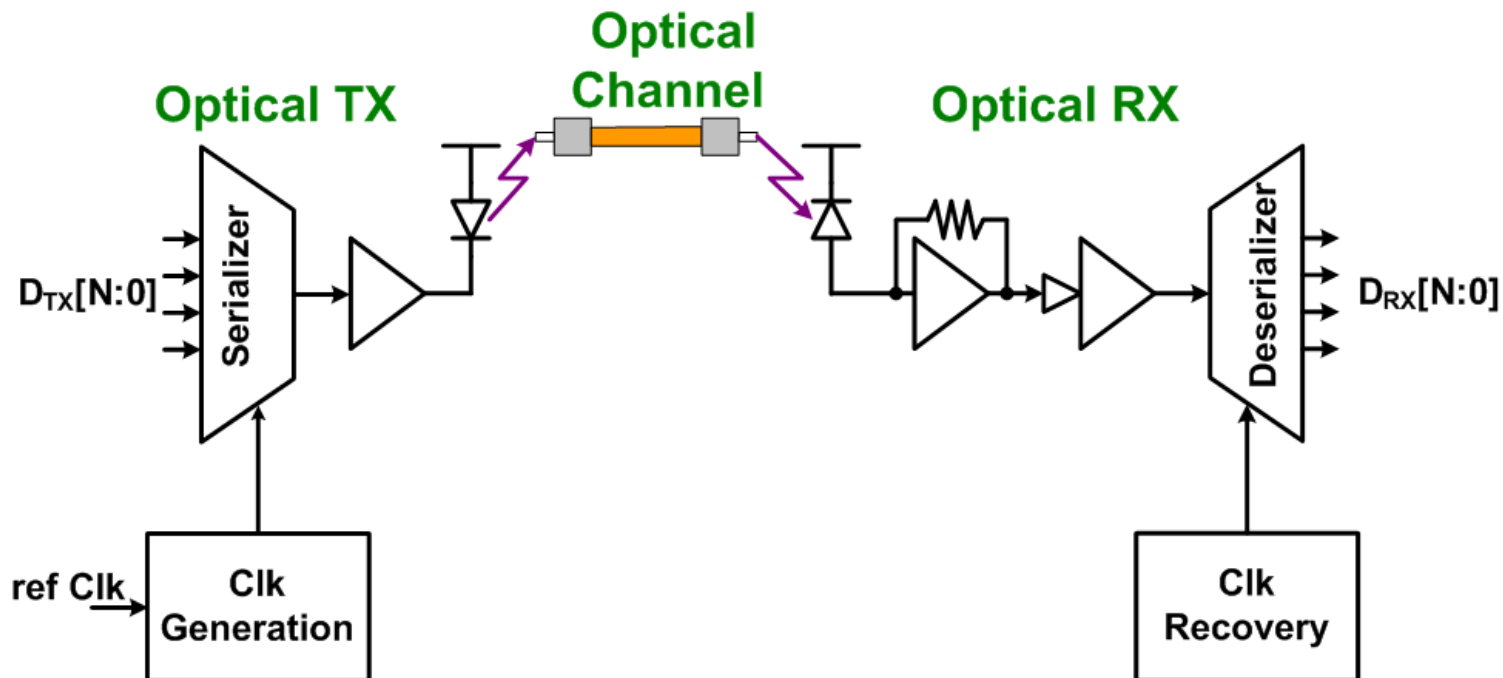

- Optical interconnects remove many channel limitations
  - Reduced complexity and power consumption
  - Potential for high information density with wavelength-division multiplexing (WDM)

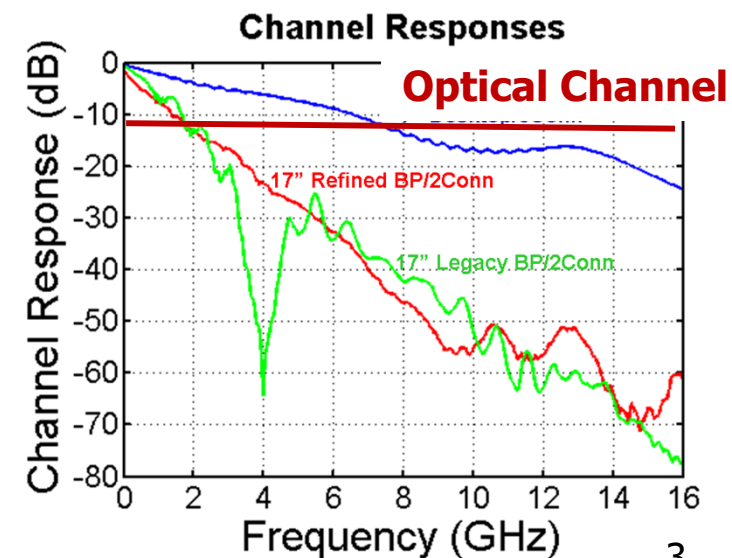

# Optical Channels

---

- Short distance optical I/O channels are typically either waveguide (fiber)-based or free-space
- Optical channel advantages
  - Much lower loss
  - Lower cross-talk
  - Smaller waveguides relative to electrical traces
  - Potential for multiple data channels on single fiber via WDM

# Outline

---

- Optical Fibers
  - General Properties
  - Loss and Bandwidth
  - Dispersion
  - Nonlinearities
  - Pulse Spreading from Chromatic Dispersion
- Silicon Photonic Waveguides
- Link Budget Examples

# Optical Fiber Cross-Section

---

[FOA]

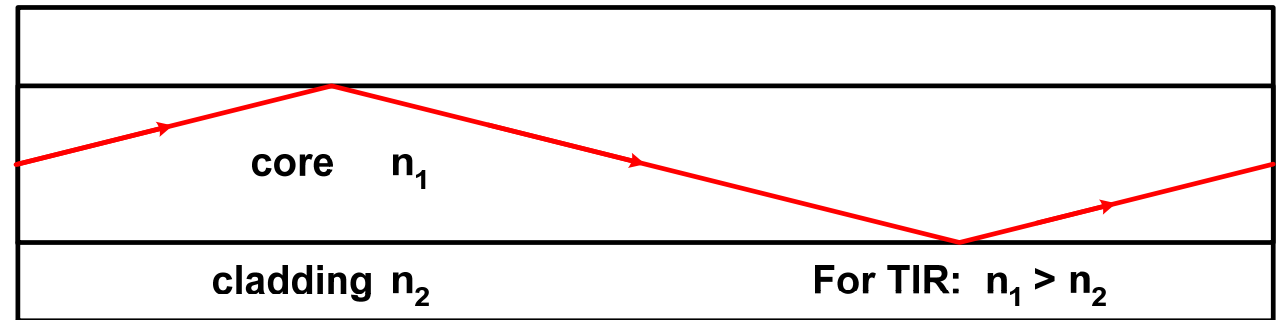
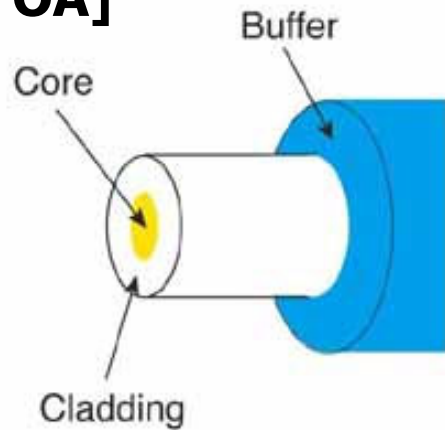

- Optical fibers confine light between a higher index core and a lower index cladding via total internal reflection

# Optical Fiber Modes

---

- For light to propagate down the fiber, the interference pattern or **mode** generated from reflecting off the fiber's boundaries must satisfy resonance conditions
- Fibers are classified based on their ability to support multiple or single modes

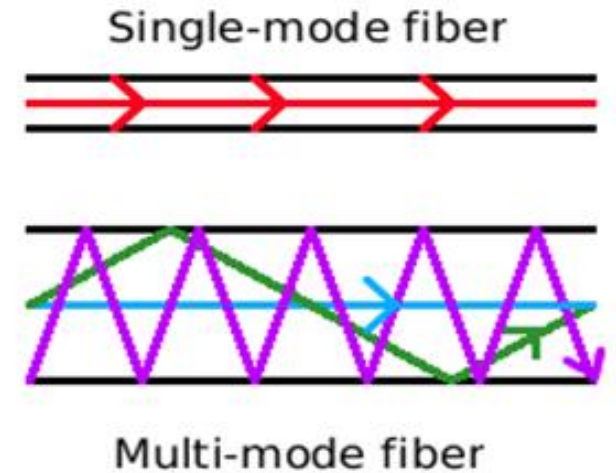

[Fibertronics]

# Multi-Mode Fibers

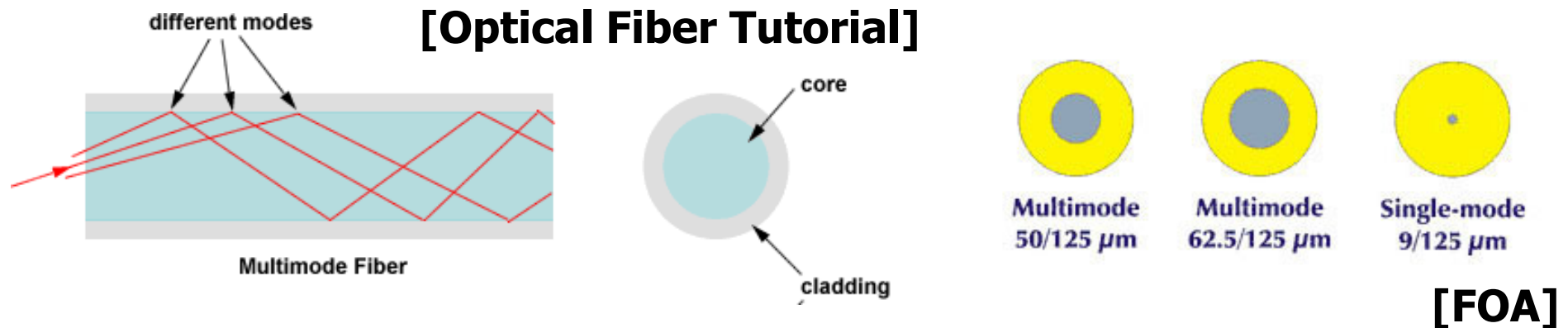

- Multi-mode fibers have large core diameters
  - Typically 50 or 62.5 $\mu\text{m}$
  - Relatively easy to couple light into
- The large diameter allows for multiple propagating modes
- Major performance limitation is modal dispersion caused by the different modes propagating at different velocities
- Typically specified with a bandwidth-distance product
  - Legacy MMF 200MHz-km
  - Optimized MMF >2GHz-km



# Single-Mode Fibers

## [Optical Fiber Tutorial]

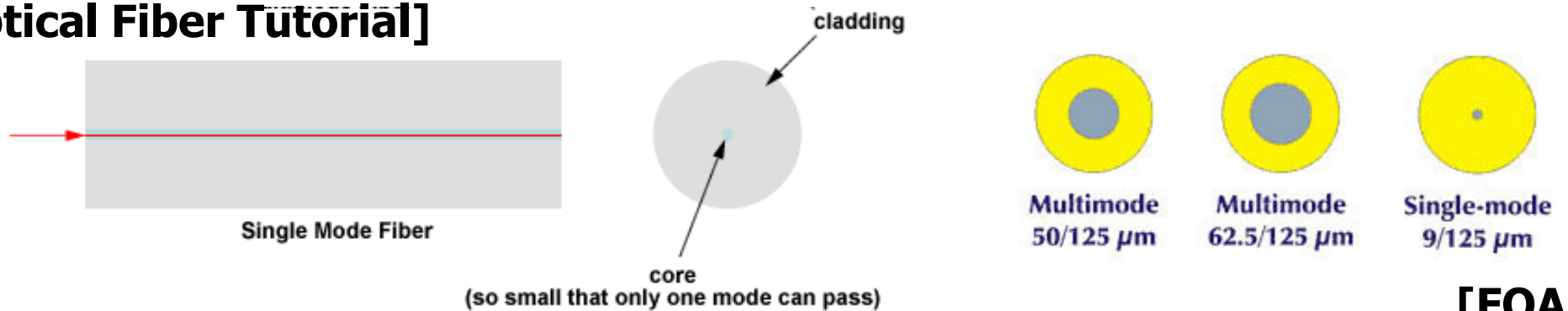

[FOA]

- Multi-mode fibers have much smaller core diameters
  - Typically 8-10 $\mu\text{m}$
  - Requires careful alignment (cost)
- The small diameter allows for only one propagating mode (with two orthogonal polarizations)
- Allows for much longer transmission distances (>100km)
- At long distance, major performance limitation is fiber loss
- Chromatic- and polarization-mode dispersion can also limit performance, but generally negligible <10kM

# Wavelength-Division Multiplexing (WDM)

## wavelength-division multiplexing (WDM)

[Xens]

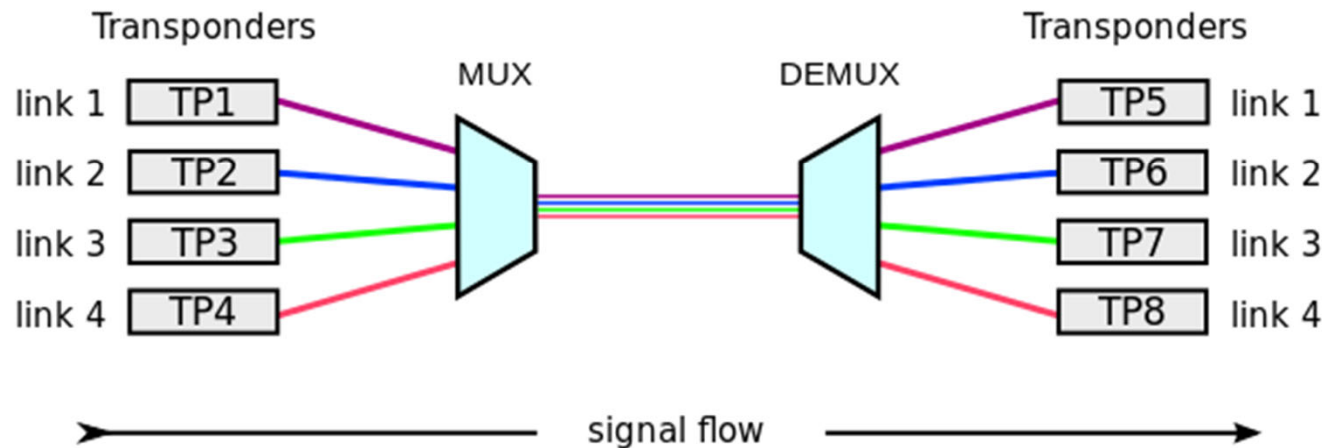

- While single-mode fibers only support one mode, one way to increase the bandwidth density is to use multiple wavelengths to transmit independent information
- This is called wavelength-division multiplexing (WDM)
- Allows efficient use of the several THz bandwidth of the optical fiber with many wavelengths independently modulated at 10s of Gb/s

# Outline

---

- Optical Fibers
  - General Properties
  - Loss and Bandwidth
  - Dispersion
  - Nonlinearities
  - Pulse Spreading from Chromatic Dispersion
- Silicon Photonic Waveguides
- Link Budget Examples

# Silica Glass Fiber Loss

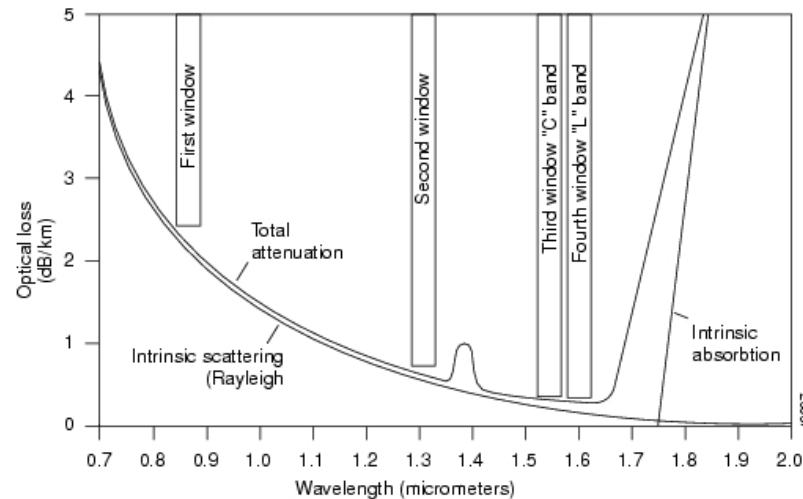

[Cisco]

- Scattering, absorption by material impurities, and other effects cause loss as the signal propagates down the fiber
- Optical fiber loss is specified in dB/**km**
  - Single-Mode Fiber loss  $\sim 0.25$ dB/km at 1550nm
  - RF coaxial cable loss  $\sim 500$ dB/km at 10GHz

# Silica Glass Fiber

## Standard Transmission Windows

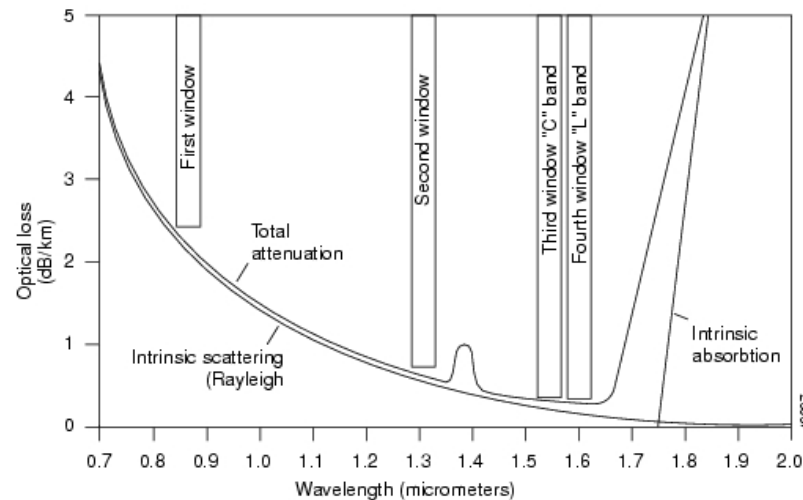

[Cisco]

- Standard silica glass fiber has a loss minimum near 1550nm
  - This region occupies a bandwidth of 95nm or 11THz!
  - Divided into 2 bands or transmission windows
    - Conventional or C-band (1530 – 1565nm)
    - Long-wavelength or L-band (1565 – 1625nm)
- Another window popular for long distance is near 1310nm, where the fiber chromatic dispersion is near zero
  - Original or O-band (1260 – 1360nm)
- A window near 850nm (800 – 900nm) is also commonly used for short distance communication due to low-cost optical sources and detectors

# Plastic Optical Fiber

---

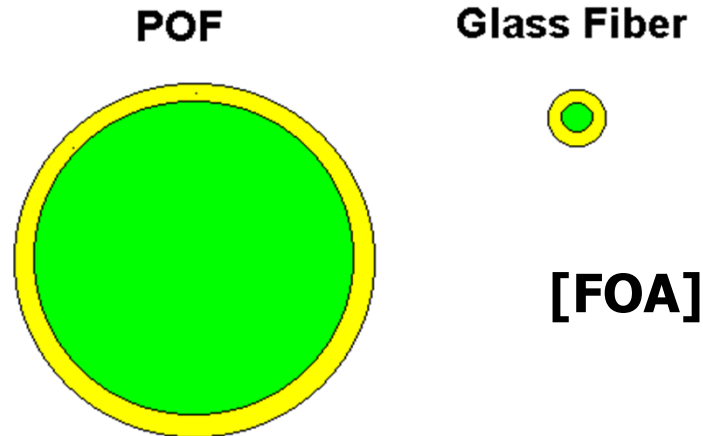

- While the vast majority of optical fibers are ultrapure silica glass, plastic optical fibers (POFs) are specialty fibers used for illumination and low-speed short-distance data links
- Cheap to manufacture
- Large 1mm core makes it very easy to couple light into
- Huge loss 180dB/km
- Some consideration for gigabit Ethernet over POF
  - IEEE 802.3 Gigabit Ethernet Over Plastic Optical Fiber Study Group (<http://www.ieee802.org/3/GEPOFSG/index.html>)

# Optical Amplifiers

---

- Optical in-line amplifiers can be utilized to boost the signal and compensate for propagation loss
- Erbium-doped fiber amplifier (EDFA)
  - Provides gain in the 1550nm range
- Raman amplifier
  - Can provide distributed gain in the transmission fiber at a selectable wavelength
- While optical amplifiers are effective, they are too bulky and expensive for high-volume short-distance (<10km) optical interconnects, which is the focus of this class

# Fiber Bandwidth and Dispersion

- While optical fiber has very wide bandwidth over which there is very low loss, there are still limits to high-speed communication
- Optical fiber can disperse a broadband signal, as different spectral components travel at different speeds
- This is **Chromatic Dispersion**

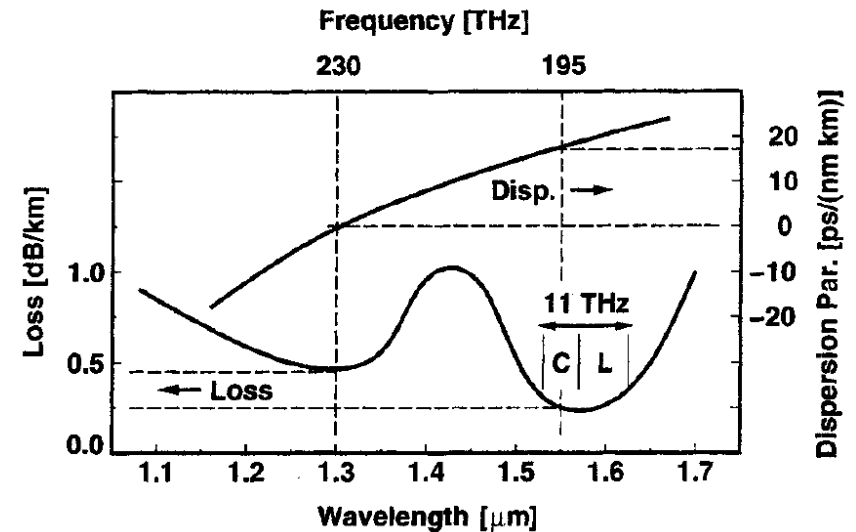

[Sackinger]



# Two Fiber Bandwidths

- Optical Carrier Bandwidth
  - Assuming a spectrally-pure signal, this is large (11THz near 1550nm)
- Modulated Signal Bandwidth
  - This is often limited by chromatic dispersion
  - 1km of standard SMF is a few 10GHz with a laser linewidth of 1nm
- WDM can take advantage of the wide carrier bandwidth with multiple carriers modulated at  $\sim 10\text{Gb/s}$  to achieve overall Tb/s communication

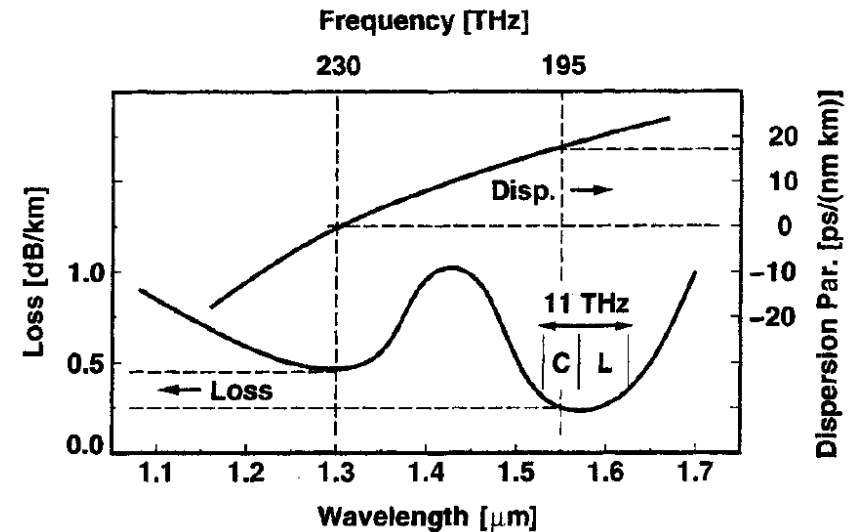

[Sackinger]

# Outline

---

- Optical Fibers
  - General Properties
  - Loss and Bandwidth
  - Dispersion
  - Nonlinearities
  - Pulse Spreading from Chromatic Dispersion
- Silicon Photonic Waveguides
- Link Budget Examples

# Dispersion

---

- Dispersion is the temporal spreading of high-speed pulses (bits)
  - Can cause intersymbol interference (ISI) and degrade BER
- Modal Dispersion
  - In a MMF, different modes of light travel at different speeds
- Chromatic Dispersion
  - In a SMF, different frequency content of a modulated optical carrier travels at different speeds
- Polarization-Mode Dispersion
  - In a SMF, different polarizations travel at different speeds

# Modal Dispersion

---

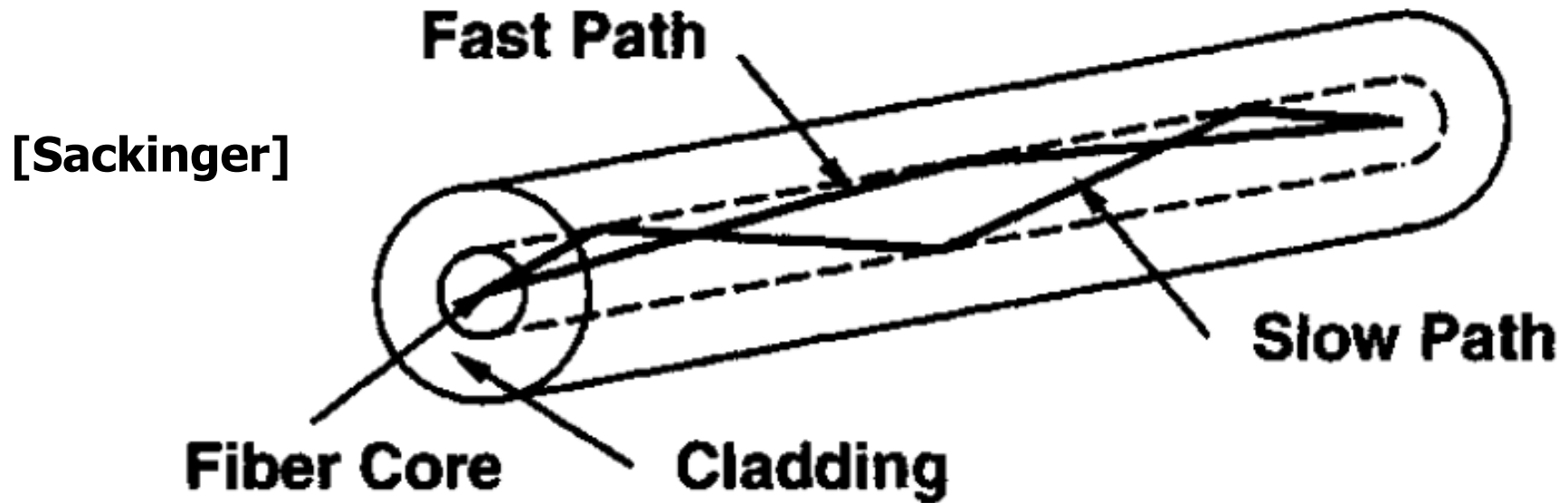

- The multiple propagating modes in a MMF have different propagation delays
- This results in pulse spreading at the receiver end or **modal dispersion**

# Modal Dispersion Example

---

- The pulse spreading is the time difference between the longest and shortest paths,  $\Delta T$

For a graded - index multimode fiber (GRIN - MMF)

$$\Delta T = \frac{(n_{cor} - n_{clad})^2}{8cn_{cor}} L$$

where  $L$  is the fiber length,  $c$  is the speed of light, and  $n_{cor}$  and  $n_{clad}$  are the core and cladding refractive indexes, respectively.

With  $n_{cor} = 1.48$ ,  $n_{cor} - n_{clad} = 0.02$ ,  $L = 1\text{km}$

$$\Delta T = \frac{(0.02)^2}{8 \left( 3 \times 10^8 \frac{m}{s} \right) 1.48} (1\text{km}) = 113 \text{ ps}$$

- For this example, if we want this to be  $\sim 10\%$  of the bit period, then this limits the maximum data rate to less than 1Gb/s at 1km
- At 10Gb/s, typical MMF lengths are 100-300m

# MMF vs SMF

---

- Modal dispersion is the primary performance differentiator between MMF and SMF
- As SMF has a small core which can only support one propagating mode, modal dispersion is not present in SMF
- Why not always use SMF?
  - Alignment into SMF is much more difficult than into a MMF, which translates into higher assembly costs
- SMF typically used in telecom applications with significant distances
  - Ultra-long-haul, long-haul, metro, access networks
- MMF typically used within building computer interconnects
- Emerging mega data centers are scaling in size & data rates, which may demand SMF systems on the interconnect scale

# Chromatic Dispersion

Relative Group Delay  
for 1km SMF

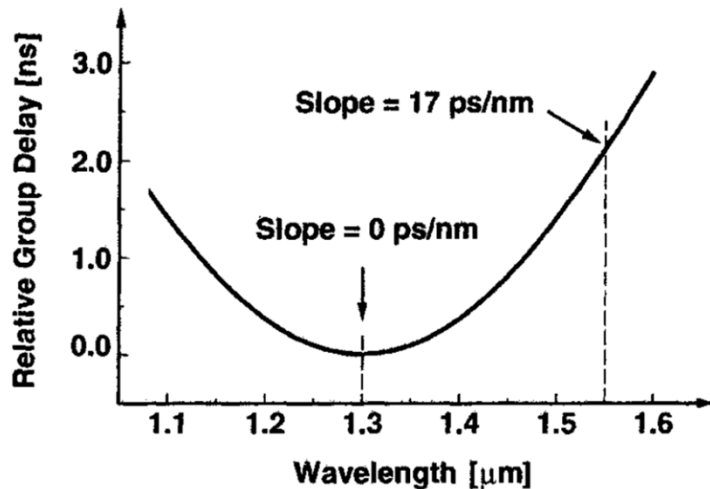

[Sackinger]

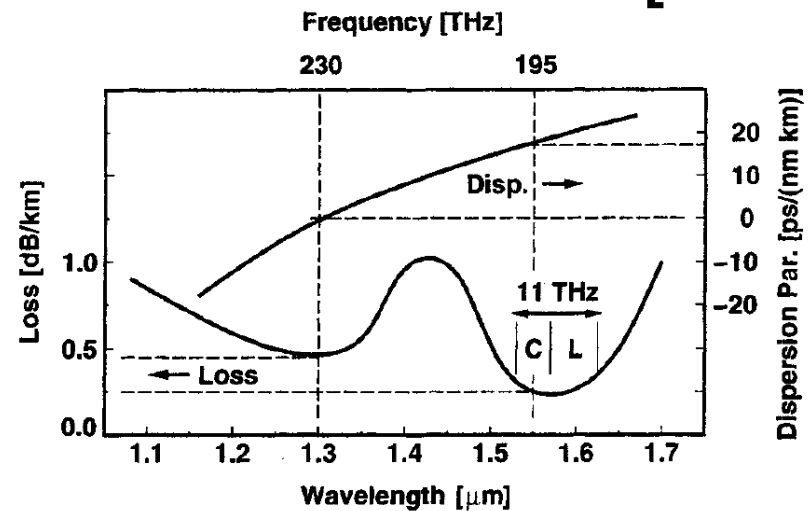

- Different wavelengths travel at different speeds down a fiber, resulting in group-velocity or **chromatic dispersion**
- Specified by the change in group delay ( $\tau$ ) per nm wavelength and km distance

$$\text{Dispersion Parameter: } D = \frac{1}{L} \cdot \frac{\partial \tau}{\partial \lambda}$$

- Standard SMF has  $D=17\text{ps}/(\text{nm}\cdot\text{km})$  at 1550nm

# Chromatic Dispersion Pulse Spreading

---

- Chromatic dispersion is a function of the transmitter spectral linewidth ( $\Delta\lambda$ ) (the nm in the denominator)
- The transmitter linewidth is a function of
  - Source laser phase noise
  - Modulation scheme
  - Modulation technique (direct vs external)
- Chromatic dispersion pulse spreading

$$\Delta T = |D| \cdot \Delta\lambda \cdot L$$

- For a 1nm spectral linewidth source, the signal will spread by 17ps over 1km of standard SMF with  $D=17\text{ps}/(\text{nm}\cdot\text{km})$  at 1550nm



# Chromatic Dispersion Mitigation

---

- As chromatic dispersion is a linear process, an easy way to mitigate it is to pass the signal through a short stretch of reverse polarity dispersion parameter fiber with a high absolute value, called dispersion compensating fiber
  - $-100\text{ps}/(\text{nm}\cdot\text{km})$  is a typical  $D$  for DCF
- Electrical equalizers can also compensate for chromatic dispersion
  - Push the complexity into the receiver IC, which may be cheaper than additional DCF
  - Optical phase information is lost in the detection process. So, the dispersion compensation may not be as good as DCF.

# Polarization-Mode Dispersion

[Sackinger]

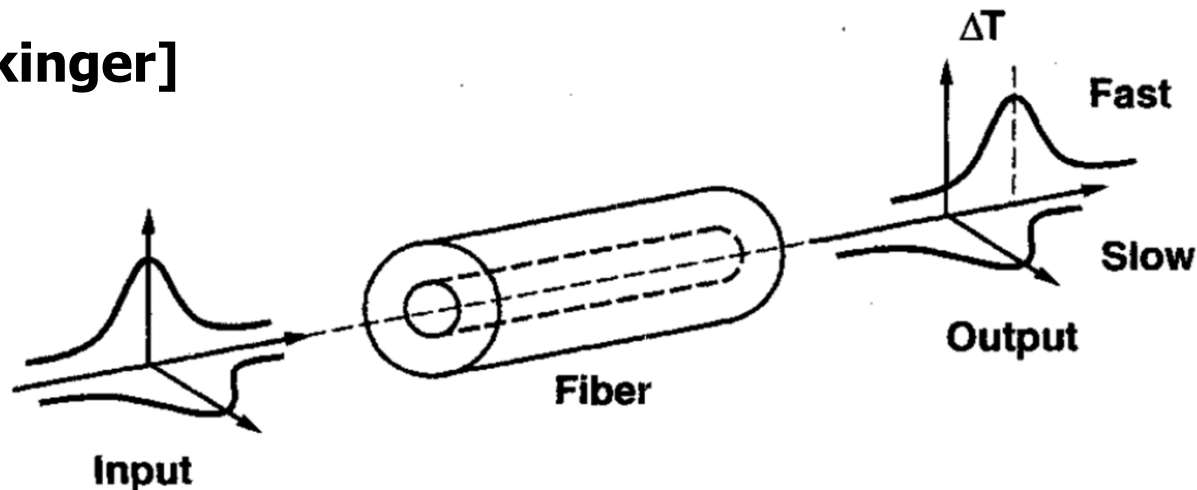

- While a SMF can only support one pathway or transverse mode, the transmitter typically has both horizontal and vertical polarization modes which both propagate down the fiber
- If a fiber has a slightly elliptical core or experiences asymmetrical mechanical stress, then the two polarization modes travel at different speeds and **polarization-mode dispersion** (PMD) results

# Polarization-Mode Dispersion Pulse Spreading

---

- The fiber's effect on the polarization changes randomly along its length, making PMD have statistical uncertainty
- The pulse spreading, averaged over multiple fibers, is

$$\overline{\Delta T} = D_{PMD} \sqrt{L}$$

where  $D_{PMD}$  is the polarization - mode dispersion parameter

- PMD is also a time-varying parameter, which can complicate compensation

# Polarization-Mode Dispersion Mitigation

---

- Luckily, PMD is not too bad
  - Legacy fiber  $D_{\text{PMD}}=2\text{ps}/\sqrt{\text{km}}$
  - New fiber  $D_{\text{PMD}}=0.1\text{ps}/\sqrt{\text{km}}$
- For data center scale interconnects (<10km), PMD can generally be neglected
- Long-haul mitigation techniques
  - Short polarization maintaining fiber with adaptively-controlled polarization controlled
  - Adaptive electronic equalizer

# Outline

---

- Optical Fibers
  - General Properties
  - Loss and Bandwidth
  - Dispersion
  - **Nonlinearities**
  - Pulse Spreading from Chromatic Dispersion
- Silicon Photonic Waveguides
- Link Budget Examples

# Nonlinearities

---

- Previously discussed loss and dispersion were linear effects
- Various nonlinear effects can distort or attenuate optical signals and/or cause crosstalk between WDM channels
- **Self-phase modulation:** Light pulses induce a varying refractive index due to the optical Kerr effect, producing a phase shift
- **Cross-phase modulation:** In a WDM system, one wavelength of light affects the phase of another via the optical Kerr effect
- **Stimulated Raman scattering:** Scattering of photons with thermally-induced vibrating fiber molecules, which produces light at different wavelengths
- **Stimulated Brillouin scattering:** Scattering of photons due to a moving index variation caused by an acoustic wave in the fiber, which produces light at different wavelengths
- **Four-wave mixing:** In a WDM system, interactions between 2 or 3 wavelengths can produce 2 or 1 wavelength, similar to intermodulation distortion in electrical systems

# Nonlinearity Mitigation

---

- Nonlinear effects are primarily an issue because there is too much optical power in the fiber
- One solution is to simply use less optical power and compensate for BER degradation with forward-error correction (FEC)
- Another thing that helps is to use fiber with a small amount of dispersion which allows the wavelengths to propagate at different speeds and have less interaction

# Outline

---

- Optical Fibers
  - General Properties
  - Loss and Bandwidth
  - Dispersion
  - Nonlinearities
  - Pulse Spreading from Chromatic Dispersion
- Silicon Photonic Waveguides
- Link Budget Examples



# Nonlinear Communication Channel

---

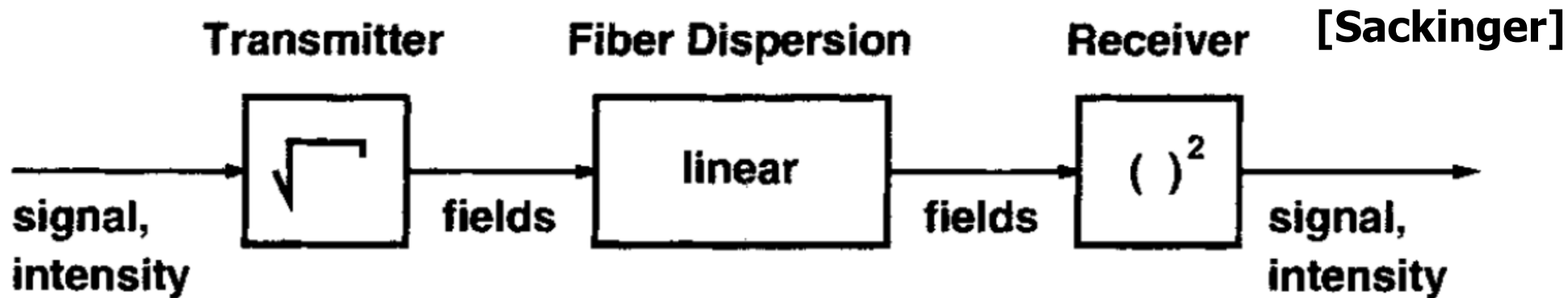

- In the most common direct detection optical communication systems, the transmitter modulates the power or intensity of the optical source
- However, the fiber's dispersion has a linear response to the light's electromagnetic field, which is proportional to the square-root of the intensity
- At the receiver, the photodetector responds to the intensity of the incoming light, which is why we often call it a "square-law detector"

# Nonlinear Communication Channel

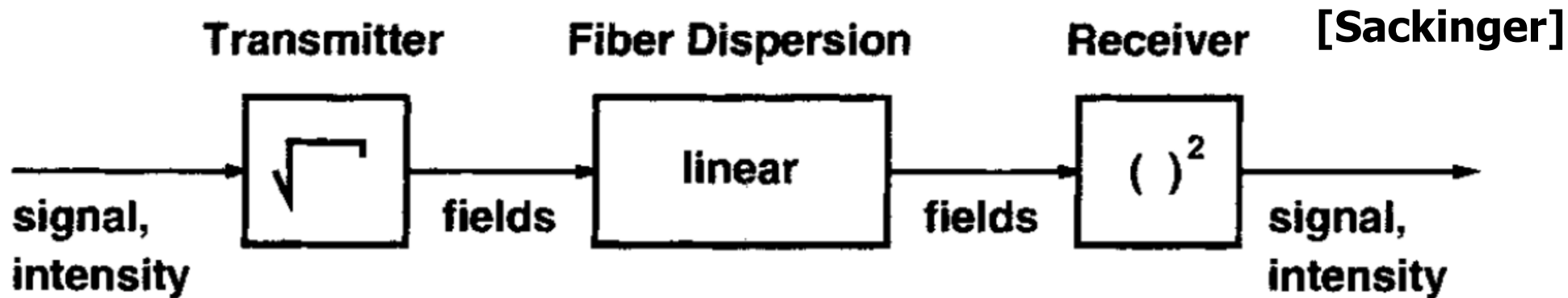

- This nonlinear system complicates things because we cannot strictly apply linear system theory
- However, if the light source has a spectrum ( $\Delta\lambda_s$ ) which is much wider than the modulation-induced bandwidth, then we can approximate the total transmitter linewidth ( $\Delta\lambda$ ) as just the light source linewidth
  - Ex: 1nm linewidth on a 1550nm laser corresponds to 125GHz
  - This is OK for a wide linewidth source, such as an LED or FP laser, but may not be applicable for high-performance DFB lasers
- This allows us to approximate the system as linear

# Fiber Impulse Response

---

Assuming a Gaussian optical source, the channel's impulse response is

$$h(t) = \exp\left(-\frac{t^2}{2(\Delta T/2)^2}\right)$$

where

$$\Delta T = |D| \cdot \Delta\lambda \cdot L$$

and  $\Delta\lambda$  is the  $2\sigma$  linewidth of the optical source

- An ideal impulse input will spread out to a  $2\sigma$  width equal to  $\Delta T$
- For example, a impulse input into a 1km fiber with  $D=17\text{ps}/(\text{nm}\cdot\text{km})$  using a 1nm linewidth optical source will spread to 17ps at the output

# Time-Domain Analysis

---

- Now that we have an impulse response, we can perform convolution with an arbitrary input to get the time-domain output signal

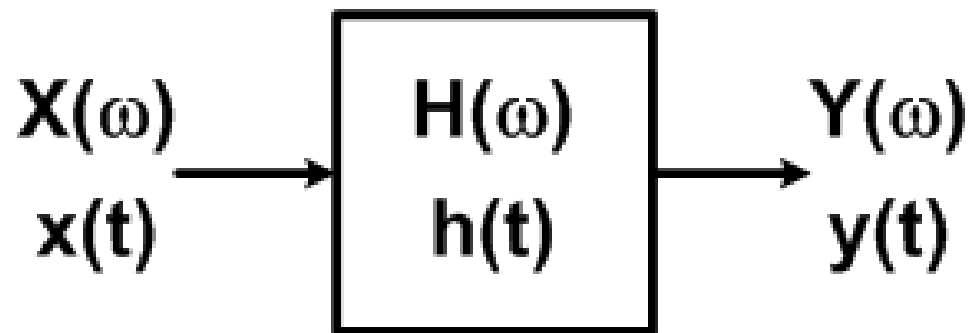

$$y(t) = h(t) * x(t) = \int_{-\infty}^{\infty} h(t - \tau)x(\tau)$$

$$Y(\omega) = H(\omega)X(\omega)$$

$$H(\omega) = F\{h(t)\}$$

# Pulse Spreading with Gaussian Inputs

- If we assume that the input pulses are Gaussian shaped, then we can quickly calculate the output pulse spreading, as the convolution of two Gaussians is also a Gaussian
- The  $2\sigma$  output pulse width will be

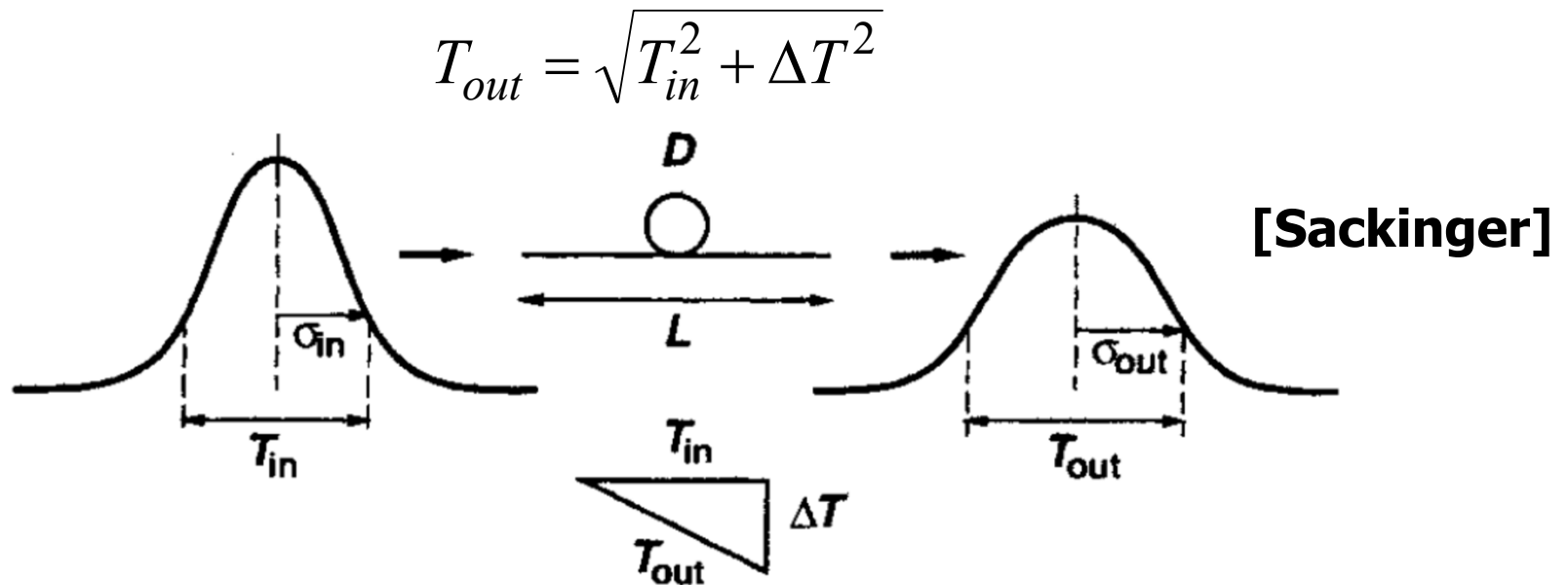

What is the pulse width of a 100ps input pulse over a 1km fiber with  $D = 17\text{ps}/(\text{nm} \cdot \text{km})$  and source  $\Delta\lambda = 1\text{nm}$  ?

$$T_{out} = \sqrt{(100\text{ps})^2 + (17\text{ps})^2} = 101.4\text{ps}$$

# Acceptable Pulse Spreading

---

- For NRZ-modulated systems, we generally try and limit the  $\Delta T$  value to less than half a bit period, where  $B$  is the bit rate (b/s)

$$\Delta T \leq \frac{1}{2B}$$

- This results in an output pulse width of

$$\sqrt{1^2 + 0.5^2} = 1.12$$

- From system analysis, it can be shown that this 12% increase in the pulse width translates into a 1dB power penalty, i.e. we have to transmit 1dB extra power to achieve the same BER

# Frequency-Domain Analysis

---

- We can transform the fiber's impulse response into the frequency domain to see the channel bandwidth

$$H(f) = \exp\left(-\frac{(2\pi f)^2 (\Delta T/2)^2}{2}\right)$$

- Setting this term equal to  $1/2$  yields the 3dB bandwidth

$$BW_{3dB} = \frac{0.375}{\Delta T} = \frac{0.375}{|D| \cdot \Delta\lambda \cdot L}$$

A 1km fiber with  $D = 17\text{ps}/(\text{nm} \cdot \text{km})$  and source  $\Delta\lambda = 1\text{nm}$   
results in a 3dB bandwidth of

$$BW_{3dB} = \frac{0.375}{(17\text{ps}/(\text{nm} \cdot \text{km}))(1\text{nm})(1\text{km})} = 22.1\text{GHz}$$

# Acceptable Fiber Bandwidth

---

- For NRZ-modulated systems, if we assume the same 1dB power penalty mentioned earlier

$$BW_{3dB} = \frac{0.375}{\Delta T} \geq \frac{0.375}{\left(\frac{1}{2B}\right)}$$

$$BW_{3dB} \geq 0.75B$$

- For a 10Gb/s system, we want 7.5GHz fiber bandwidth to avoid excessive distortion



# Narrow-Linewidth Source

---

- Recall that the key assumption for the analysis on the previous slides was that the light source has a spectrum ( $\Delta\lambda_s$ ) which is much wider than the modulation-induced bandwidth
- However, for a high-performance (DFB) laser, this may not be the case
- For the case where the modulated signal sets the bandwidth, due to the non-linear channel we cannot strictly apply the equations shown on the previous slide
- However, we can still use them to gain some intuition on the system performance

# Outline

---

- Optical Fibers
  - General Properties
  - Loss and Bandwidth
  - Dispersion
  - Nonlinearities
  - Pulse Spreading from Chromatic Dispersion
- Silicon Photonic Waveguides
- Link Budget Examples

# Silicon Photonic Waveguides

## Ridge waveguide used in a ring resonator modulator

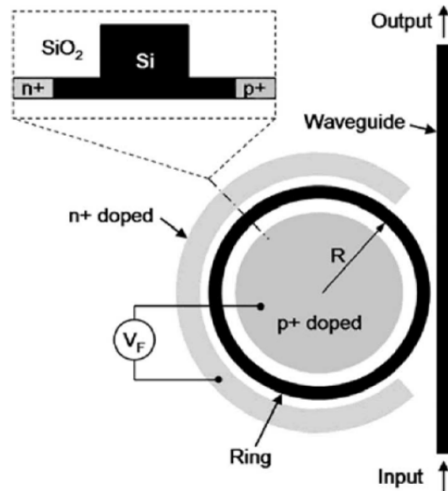

## Wire/rectangular waveguide

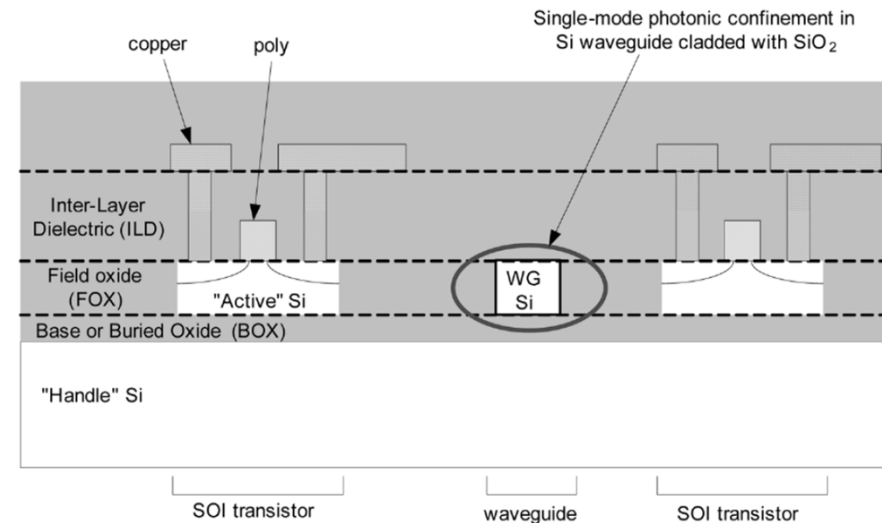

- Waveguides can be made in CMOS processes with a silicon core surrounded by an SiO<sub>2</sub> (or similar) cladding
- Common structures are the "ridge" and "wire/rectangular" waveguides

# Silicon Photonic Waveguides

## Wire/rectangular waveguide

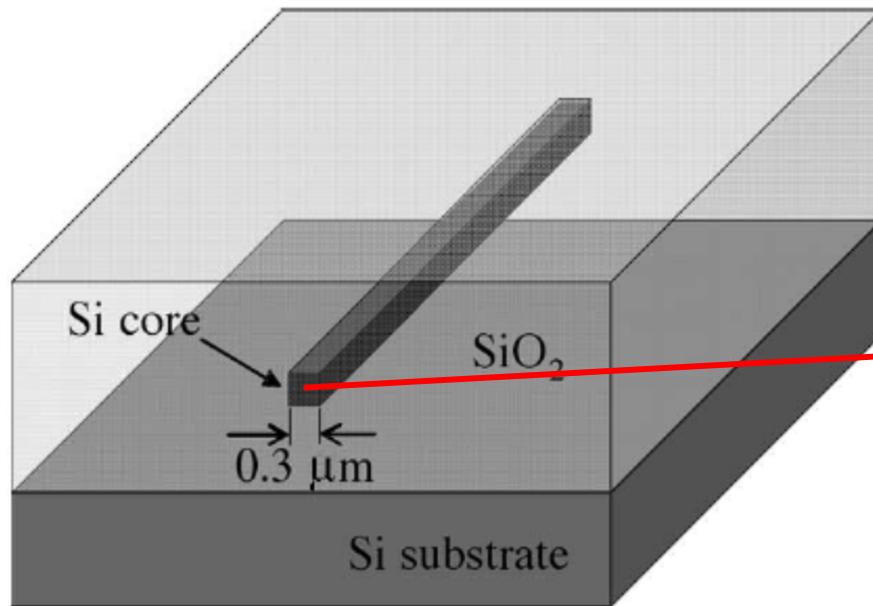

**Width = 320nm**  
**Height = 220nm**

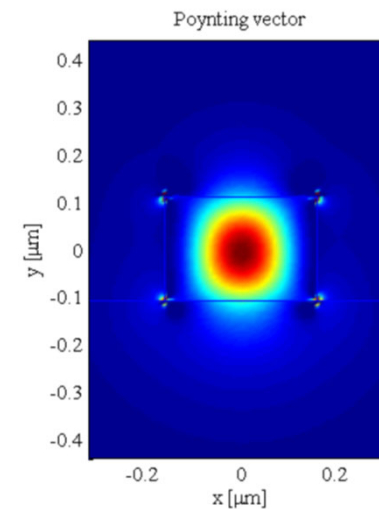

- The high index contrast between Si ( $\sim 3.5$ ) and SiO<sub>2</sub> ( $\sim 1.5$ ) allow for submicron cross-section dimensions
- The evanescent field outside the core typically decays within 300nm, allowing for tight pitches of parallel waveguides
- Tight bending radius ( $< 5\ \mu\text{m}$ ) is possible, allowing for compact photonic integrated circuits

# TE & TM Polarization Modes

---

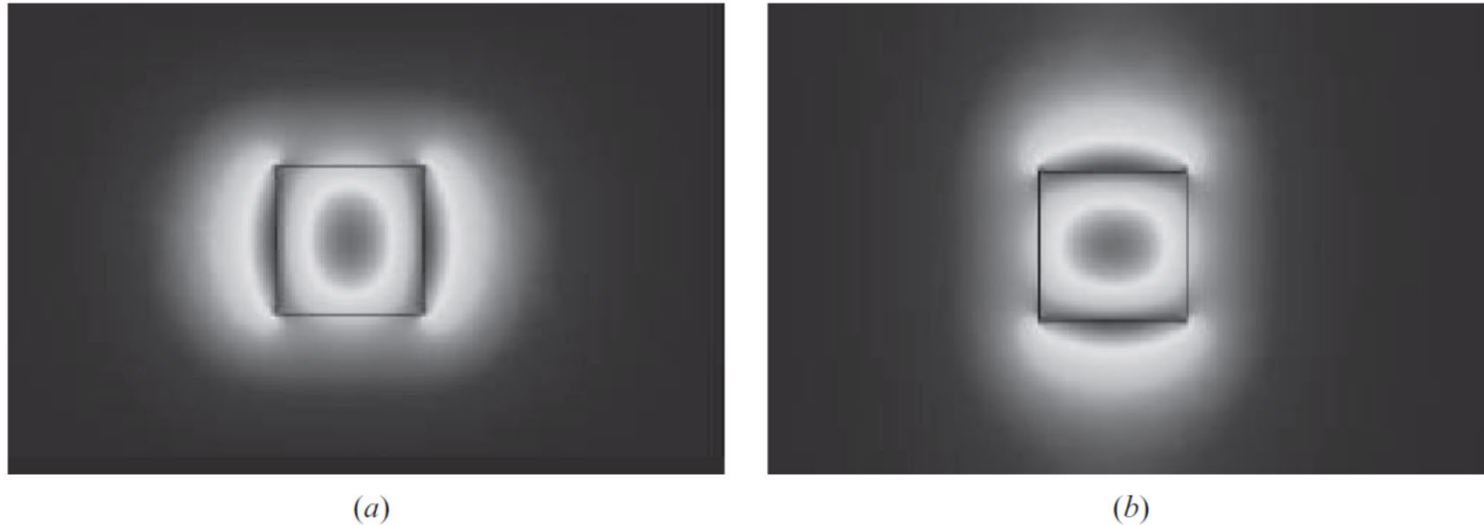
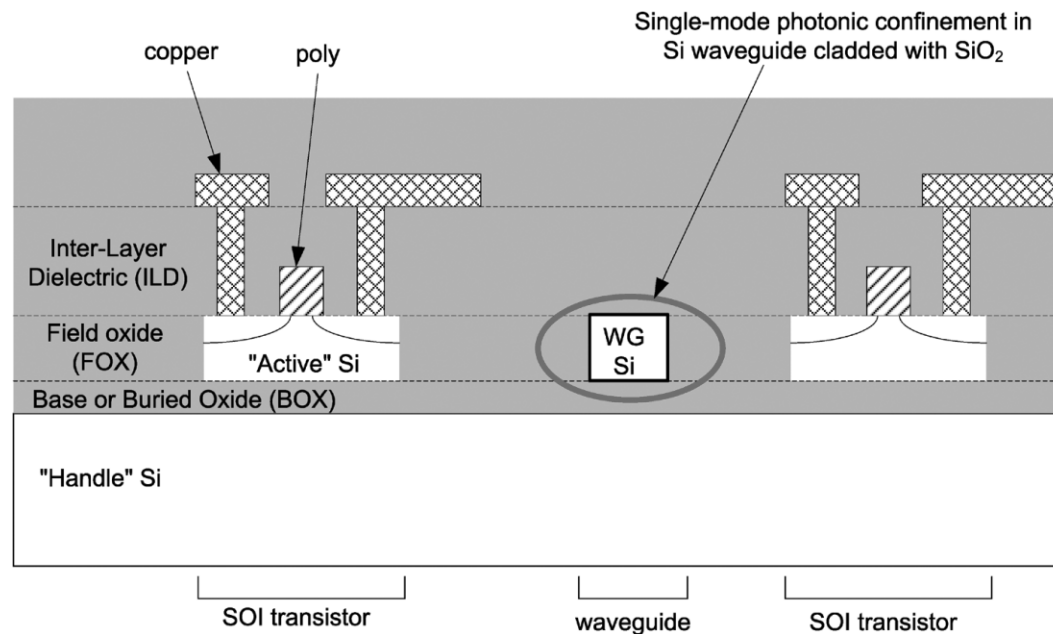

**Figure 2.14** Field profiles for: (a) TE; (b) TM polarisation in a small strip silicon waveguide

- While on-chip silicon waveguides are most commonly single transversal mode, they generally support both TE and TM polarization modes
- Depending on the waveguide cross-section, these polarization modes can have different propagation constants. Although, PMD should be negligible for on-chip distances.
- TE modes have higher field intensity at the sidewalls, which are harder to keep smooth in the fabrication process
- This sidewall roughness results in typically higher loss for the TE mode

# CMOS Waveguides – SOI

- SOI processes have thicker buried oxide layers to sufficiently confine the optical mode
- Allows for relatively low-loss waveguides, with typical reported values of  $\sim 1\text{dB/cm}$



[Narasimha JSSC 2007]

# CMOS Waveguides – Bulk CMOS

- Waveguides can be made in a bulk process with a polysilicon core surrounded by an SiO<sub>2</sub> cladding
- However, thin STI layer means a significant portion of the optical mode will leak into the Si substrate, causing significant loss (1000dB/cm)
- Significant post-processing is required for reasonable loss (10dB/cm) waveguides in a bulk process

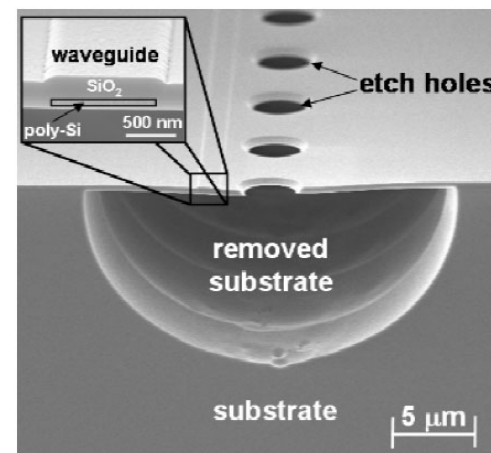
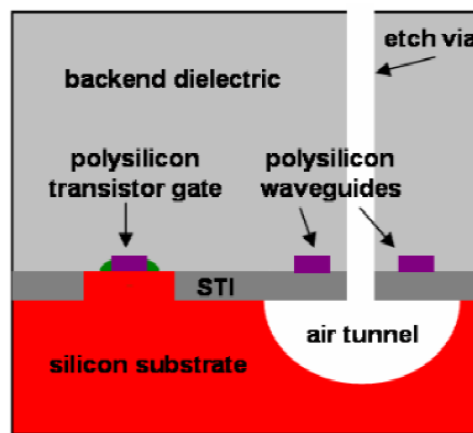

[Holzwarth CLEO 2008]

# CMOS Waveguides – Bulk CMOS

[Sun JSSC 2015]

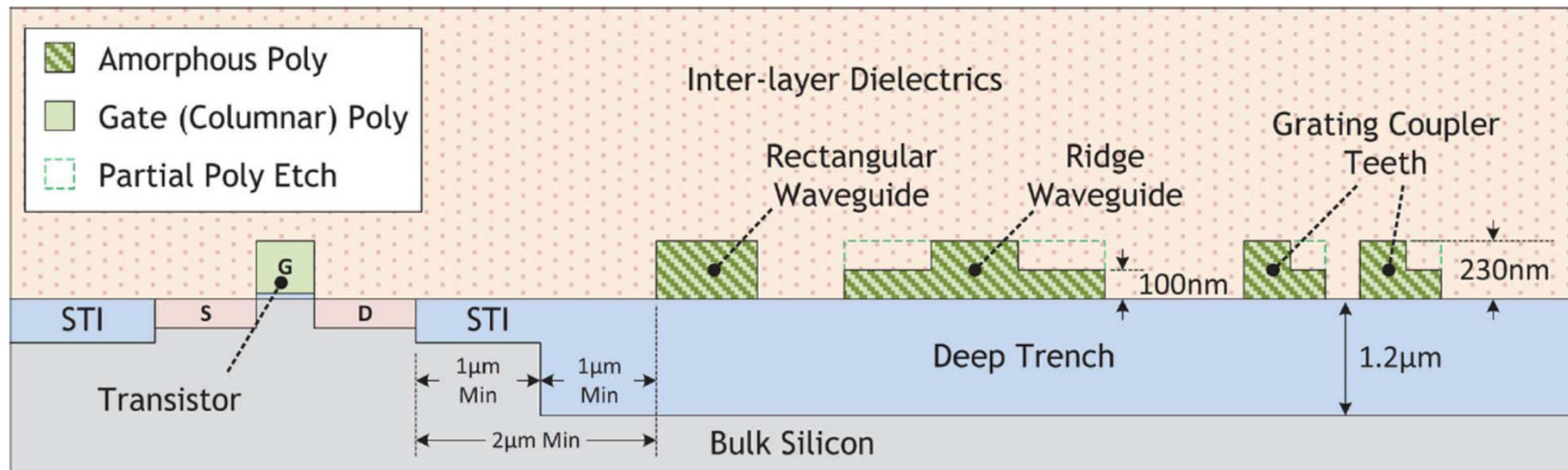

- Introducing additional processing steps can also allow photonics in bulk CMOS
- Key step is the introduction of a deep-trench isolation oxide layer between the waveguides and the substrate
- Another partial polysilicon etch step allows for ridge waveguides and improved coupler design
- Reported loss is still close to 10dB/cm



# CMOS Waveguides – Back-End Processing

- Waveguides & optical devices can be fabricated above metallization
- Reduces active area consumption
- Allows for independent optimization of transistor and optical device processes
- The silicon nitride waveguides are slightly larger, with 450nm X 500nm dimensions
- Similar loss of  $\sim 1\text{dB/cm}$  is reported

[Young JSSC 2010]

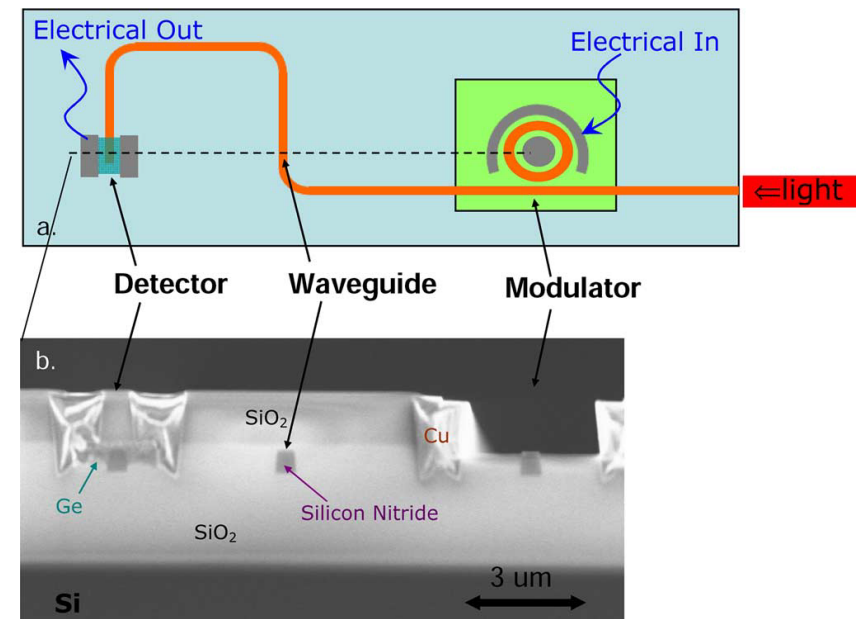

# Coupling In & Out of the Chip

---

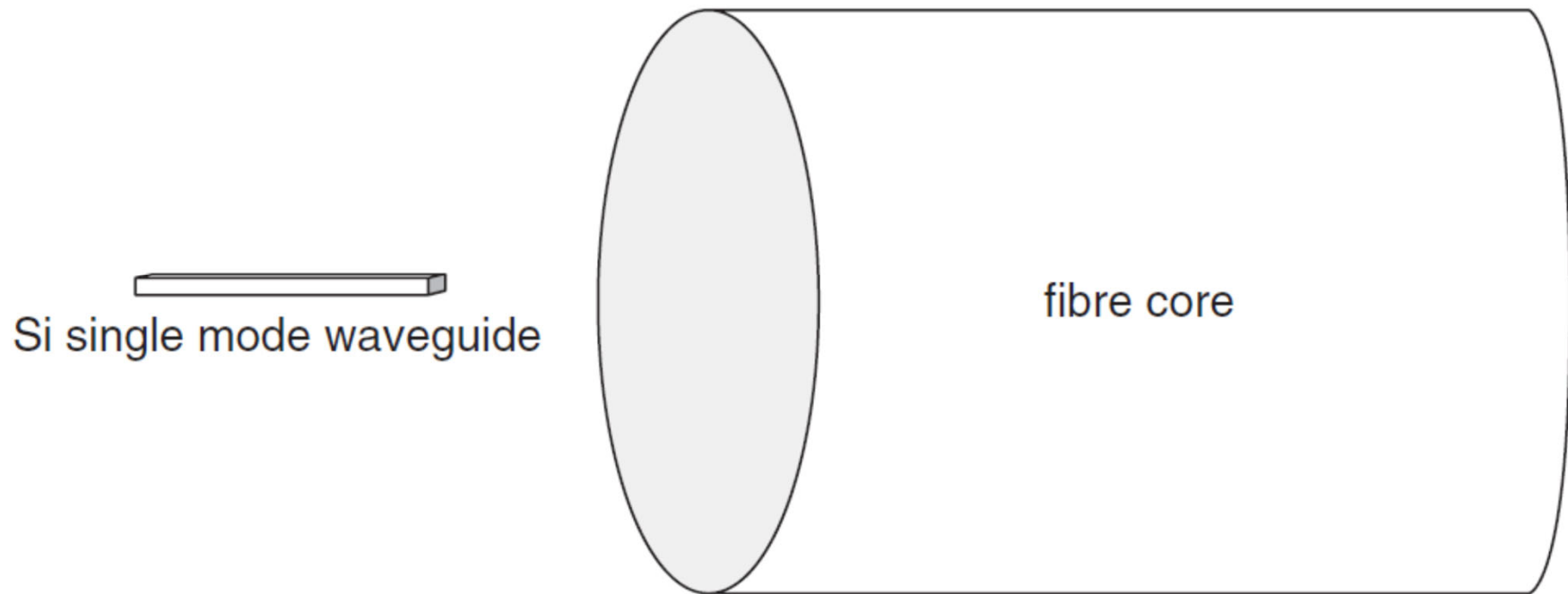

- Butt or edge coupling of small silicon waveguides is inefficient, with  $\sim 20\text{dB}$  of loss common
- Thus, efficient mode converters or couplers are necessary

# Vertically-Tapered Waveguide

---

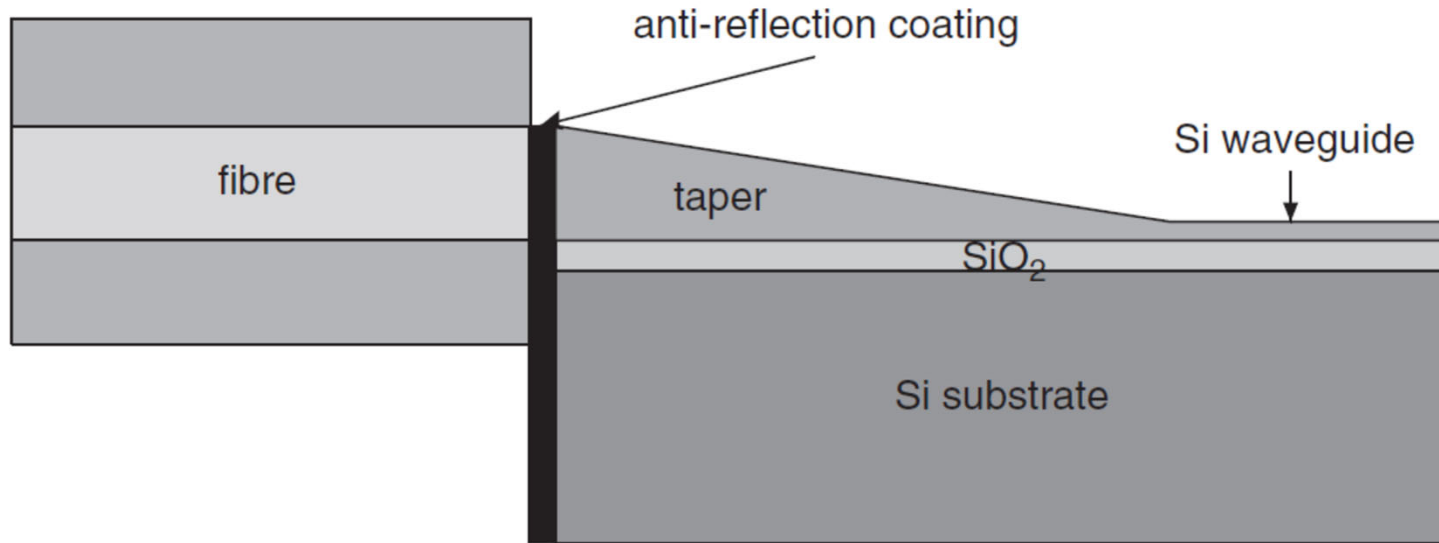

- Waveguide height is increased near the edge of the chip to create an adiabatic taper
- Ideally, this transforms the fiber mode to the waveguide mode
- Reported losses are near 3dB

# Inverted-Tapered Waveguide

---

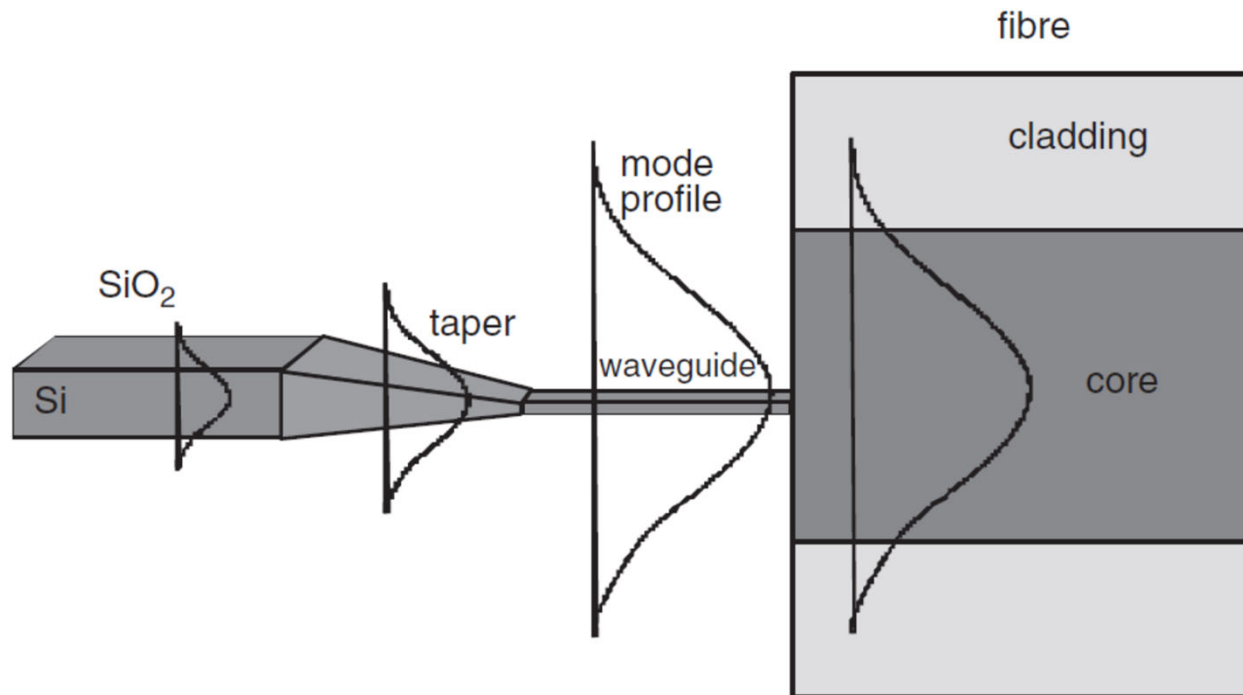

- Tapering the waveguide height down can cause the mode to become delocalized from the waveguide core and better match the fiber core
- Can actually achieve better coupling, with better than 1dB loss reported

# Surface Grating Couplers

---

- Surface grating couplers are often more convenient for systems
- Here the fiber is brought in at a specific angle and the vertical light is coupled into the horizontal waveguide
- Loss of 1-1.5dB has been reported for over a 20nm (1537-1557nm) range

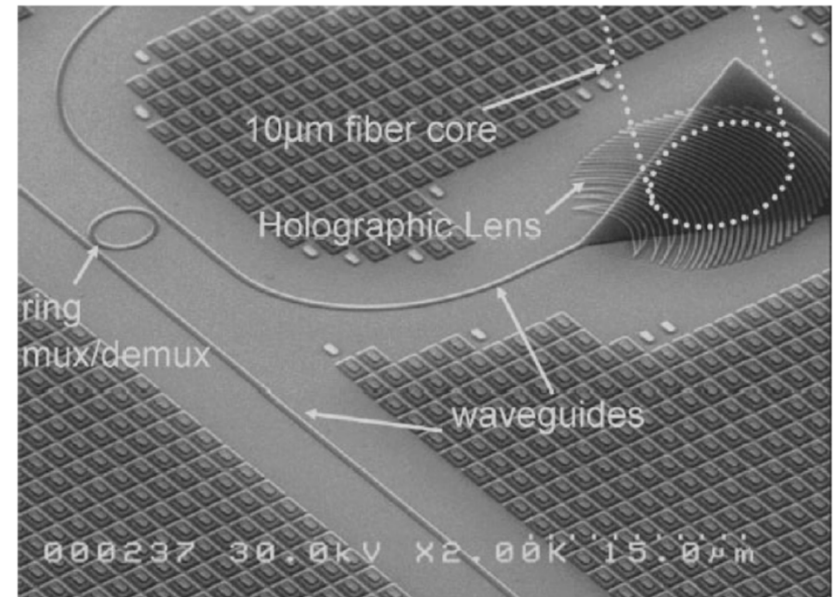

# Outline

---

- Optical Fibers
  - General Properties
  - Loss and Bandwidth
  - Dispersion
  - Nonlinearities
  - Pulse Spreading from Chromatic Dispersion
- Silicon Photonic Waveguides
- Link Budget Examples

# VCSEL-Based MMF Link Budget

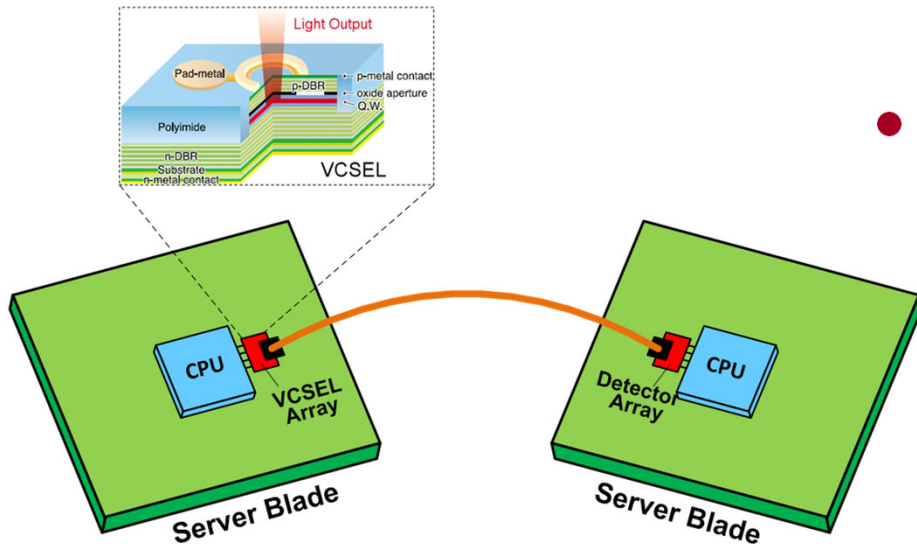

- Key assumptions
  - 850nm VCSEL w/  $P_{avg}=3.0\text{dBm}$ ,  $ER=7.3\text{dB}$ 
    - $OMA = 4.38\text{dBm}$  (2.74mW)
  - Short distance link with no significant fiber loss or dispersion

Item	Loss (dB)	$P_1$ (mW)	$P_0$ (mW)	$P_{\Delta}$ (mW)	$P_{avg}$ (mW)
VCSEL w/ $P_{avg}=3.0\text{dBm}$ , $ER=7.3\text{dB}$		3.36	0.63	2.74	2.00
VCSEL to MMF Coupling	-1.1	2.61	0.49	2.13	1.55
MMF Loss (2.3dB/km)	0	2.61	0.49	2.13	1.55
MMF to PD Coupling	-1.1	2.03	0.38	1.65	1.20
Margin	-3	1.02	0.19	0.83	0.60
<b>RX OMA Sensitivity (dBm)</b>				<b>-0.83</b>	
ER Penalty	-1.64	0.83	0	0.83	0.41
<b>Ideal ER RX <math>P_{avg}</math> Sensitivity (dBm)</b>					<b>-3.84</b>

# VCSEL-Based MMF Link Budget

- The link distance can either be limited by fiber loss (RX sensitivity) or the fiber's modal dispersion
- High performance OM5 multi-mode fiber
  - Loss = 2.3dB/km
  - Bandwidth = 4.7GHz\*km
- For NRZ signaling
  - Fiber BW  $\geq 0.75 * \text{Data Rate}$

Assuming an RX w/  
-8.0dBm OMA Sensitivity

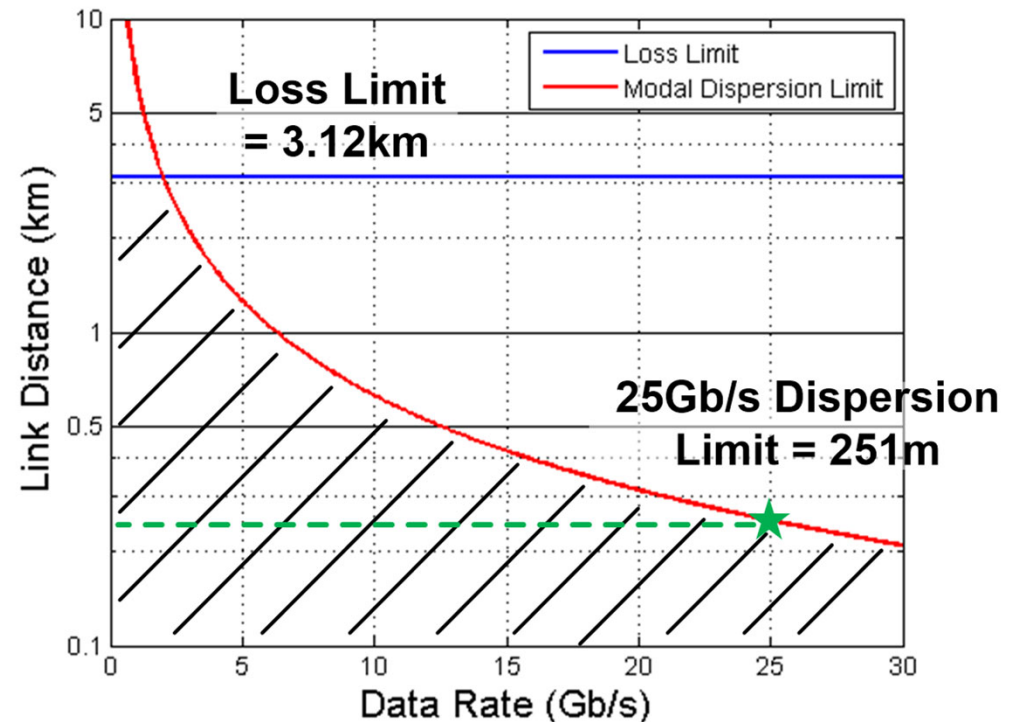

- Distance is suitable for an HPC system, but perhaps not a large data center



# RRM-Based SMF Link Budget

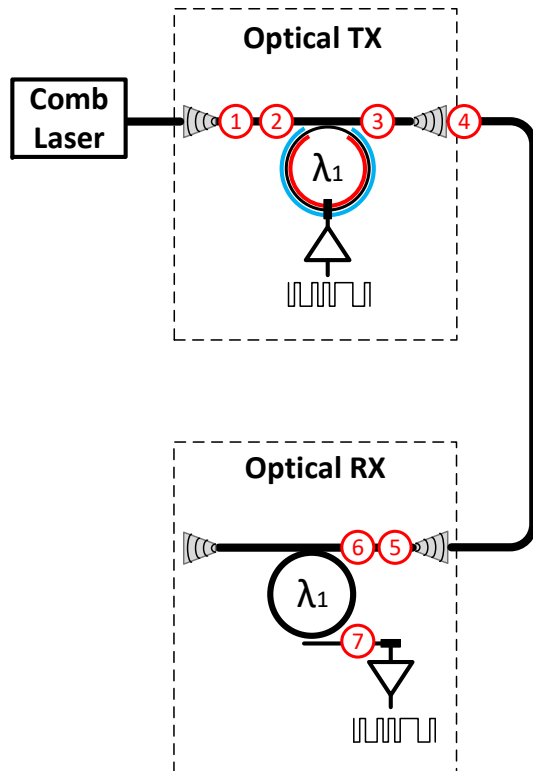

Item	Loss (dB)	$P_1$ (mW)	$P_0$ (mW)	$P_{\Delta}$ (mW)	$P_{avg}$ (mW)
Source CW Laser w/ $P=5.3\text{dBm}$		3.39			
Laser to TX Chip Coupling (1)	-2.8	1.78			
Waveguide Loss (2)	-0.55	1.57			
Modulator Insertion Loss (3)	-1.5	1.11			
Modulator ER=7dB		1.11	0.22	0.89	0.67
TX Chip to SMF Coupling (4)	-2.8	0.58	0.12	0.47	0.35
SMF Loss (XXdB/km)	0	0.58	0.12	0.47	0.35
SMF Coupling to RX Chip (5)	-2.8	0.31	0.06	0.24	0.18
Waveguide Loss (6)	-0.55	0.27	0.05	0.22	0.16
Drop Filter Insertion Loss (7)	-0.25	0.25	0.05	0.20	0.15
Margin	-3	0.13	0.03	0.10	0.08
<b>RX OMA Sensitivity (dBm)</b>				<b>-9.92</b>	
ER Penalty	-1.76	0.10	0	0.10	0.05
<b>Ideal ER RX <math>P_{avg}</math> Sensitivity (dBm)</b>					<b>-12.93</b>

- Key assumptions

- Continuous wave (CW) source laser  $P_{avg}=5.3\text{dBm}$
- Short distance link with no significant fiber loss or dispersion

# RRM-Based SMF Link Budget

- The link distance can either be limited by fiber loss (RX sensitivity) or the fiber's chromatic dispersion

- SMF-28 Ultra Optical Fiber

Wavelength (nm)	Loss (dB/km)	Dispersion (ps/(nm*km))
1310	0.32	0
1550	0.18	<b>18</b>

- Chromatic dispersion limit

$$L \leq \frac{1}{2D \left( \frac{\lambda^2}{c} \right) B^2}$$

where  $D$  is the fiber dispersion parameter and  $B$  is the signal bandwidth, which is assumed to be the data rate for binary NRZ modulation.

**Assuming an RX w/ -14.9dBm OMA Sensitivity**

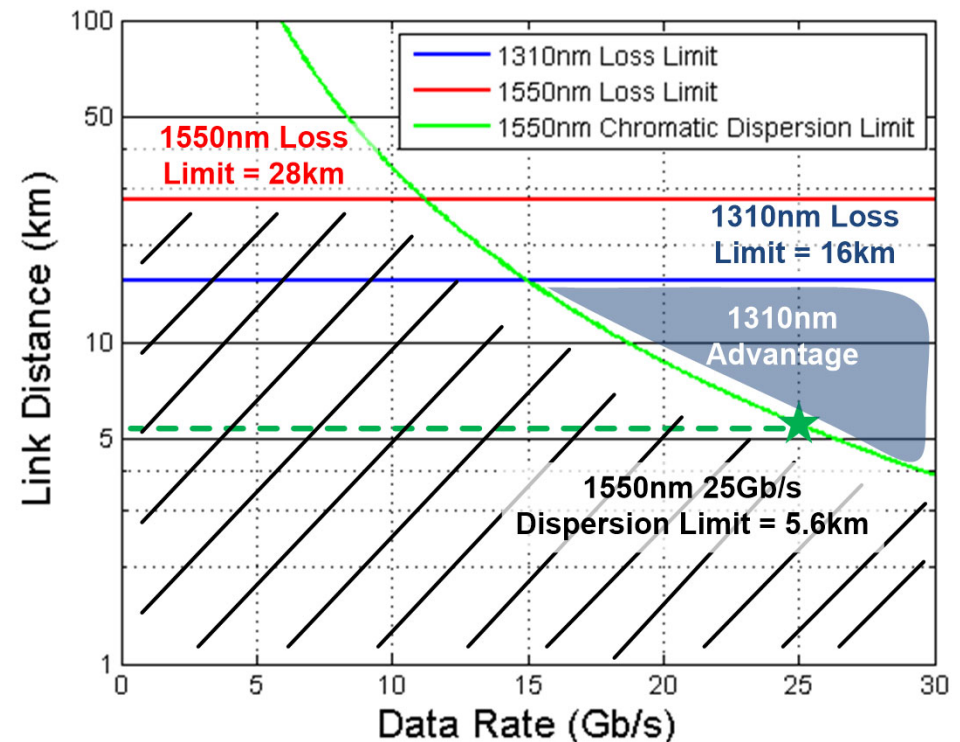

- Distance is suitable for a large data center
- 1310nm has a significant distance advantage at higher data rates

# Next Time

---

- Photodetectors
  - Sackinger Chapter 3