

Deep Learning in NLP

Many slides adapted from Richard Socher, Tom Mitchell

What's Deep Learning (DL)?

- Deep learning is a subfield of machine learning
- Most machine learning methods work well because of human-designed representations and input features
 - For example: features for finding named entities like locations or organization names (Finkel, 2010):
- Machine learning becomes just optimizing weights to best make a final prediction

Feature	NER
Current Word	✓
Previous Word	✓
Next Word	✓
Current Word Character n-gram	all
Current POS Tag	✓
Surrounding POS Tag Sequence	✓
Current Word Shape	✓
Surrounding Word Shape Sequence	✓
Presence of Word in Left Window	size 4
Presence of Word in Right Window	size 4

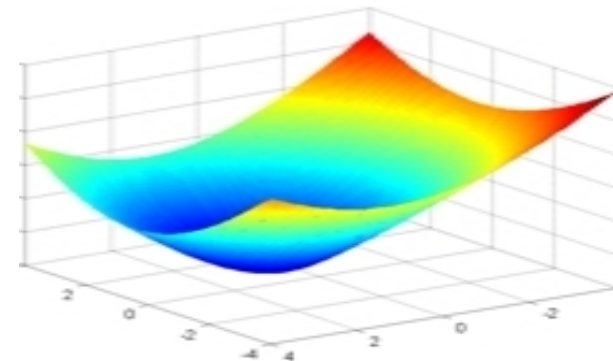

Machine Learning vs Deep Learning

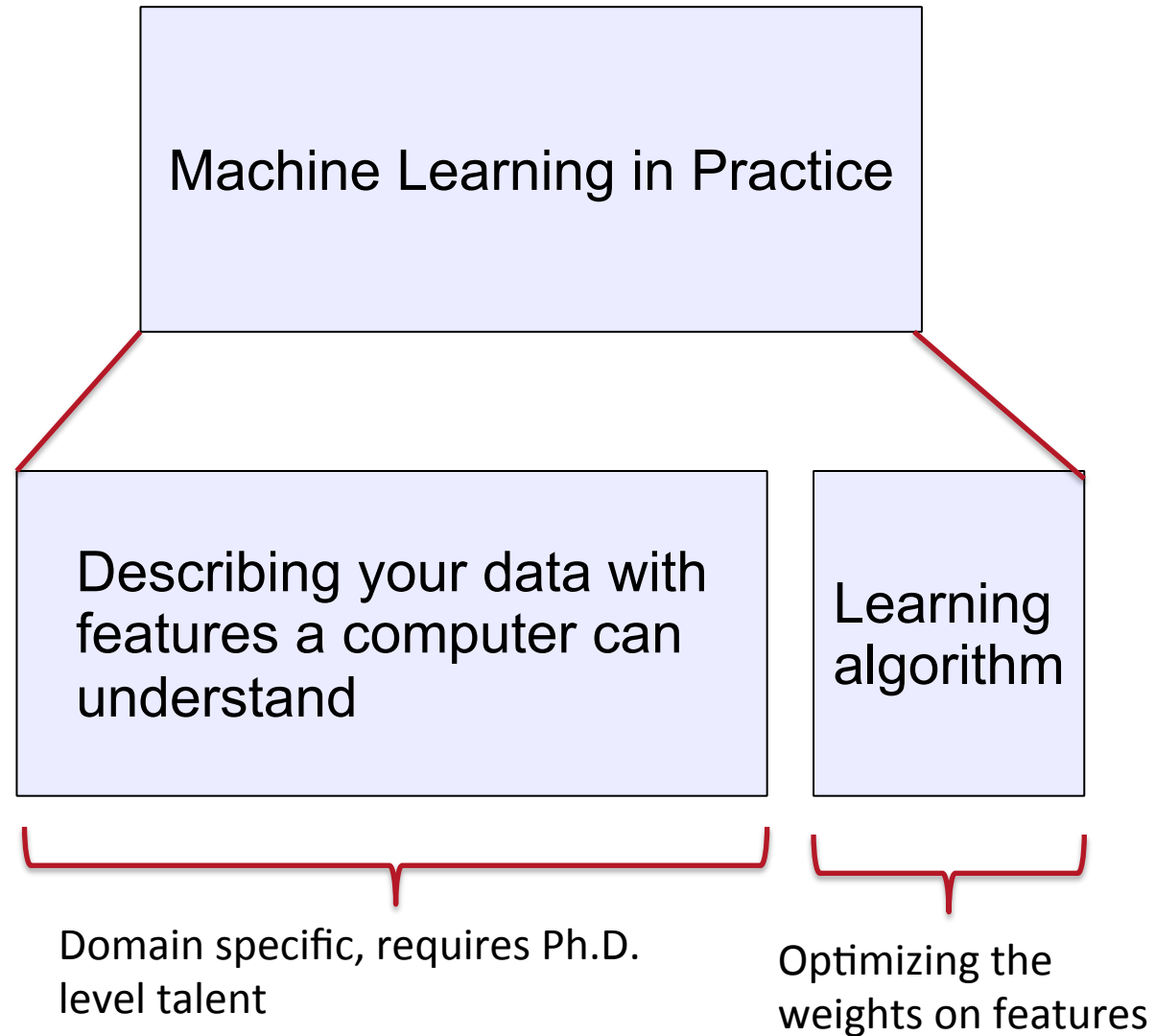

What's Deep Learning (DL)?

- Representation learning attempts to automatically learn good features or representations
- Deep learning algorithms attempt to learn (multiple levels of) representation and an output
- From “raw” inputs \mathbf{x} (e.g. words)

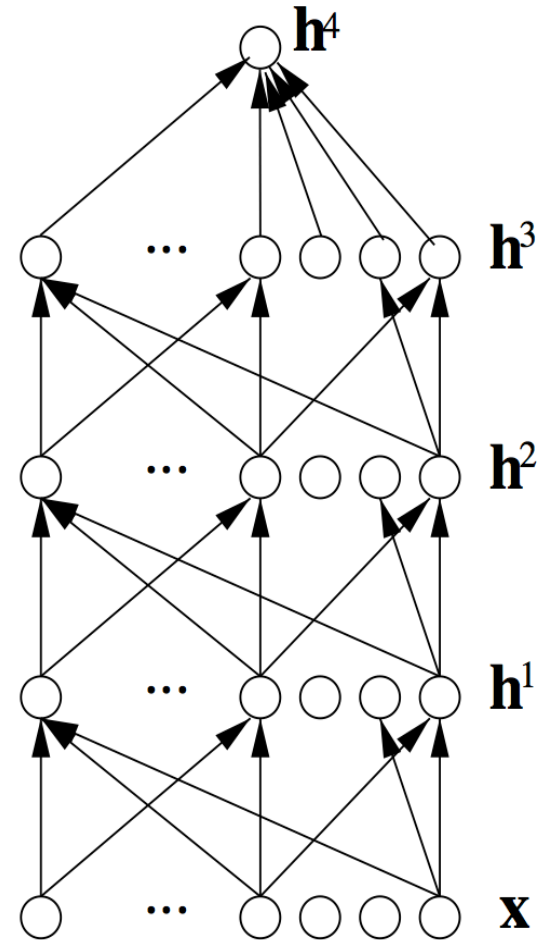

Reasons for Exploring Deep Learning

- Manually designed features are often over-specified, incomplete and take a long time to design and validate
- **Learned Features** are easy to adapt, fast to learn
- Deep learning provides a very flexible, (almost?) universal, learnable framework for **representing** world, visual and linguistic information.
- Deep learning can learn **unsupervised** (from raw text) and **supervised** (with specific labels like positive/negative)

Reasons for Exploring Deep Learning

- In 2006 **deep** learning techniques started outperforming other machine learning techniques. Why now?
 - DL techniques benefit more from a lot of data
 - Faster machines and multicore CPU/GPU help DL
 - New models, algorithms, ideas
- **Improved performance** (first in speech and vision, then NLP)

Deep Learning for Speech

- The first breakthrough results of “deep learning” on large datasets happened in speech recognition
- Context-Dependent Pre-trained Deep Neural Networks for Large Vocabulary Speech Recognition
Dahl et al. (2010)

Acoustic model	Recog \ WER	RT03S FSH	Hub5 SWB
Traditional features	1-pass -adapt	27.4	23.6
Deep Learning	1-pass -adapt	18.5 (-33%)	16.1 (-32%)

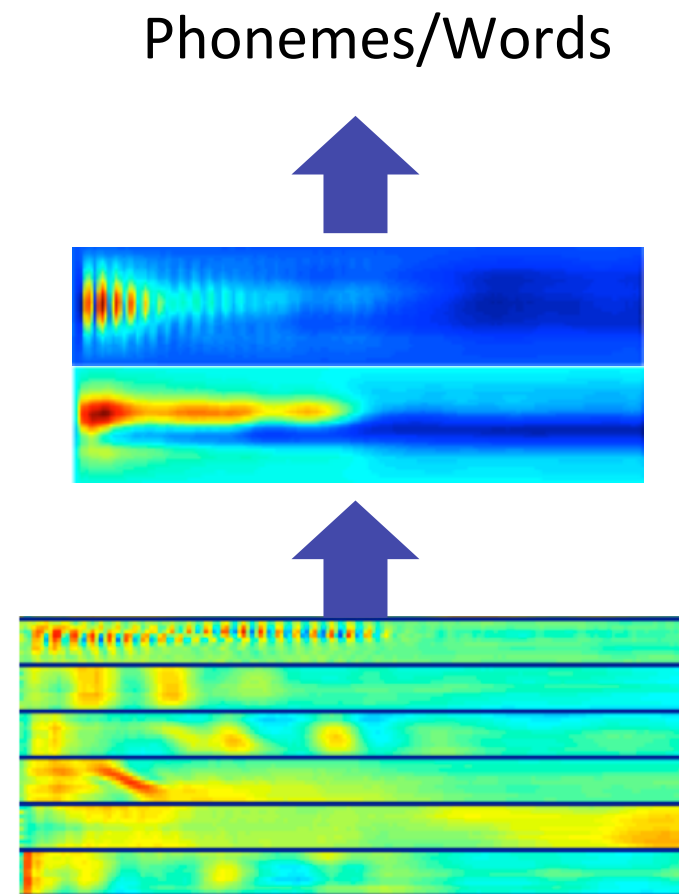

Deep Learning for Computer Vision

- Most deep learning groups have (until recently) largely focused on computer vision
- Break through paper: ImageNet Classification with Deep Convolutional Neural Networks by Krizhevsky et al. 2012

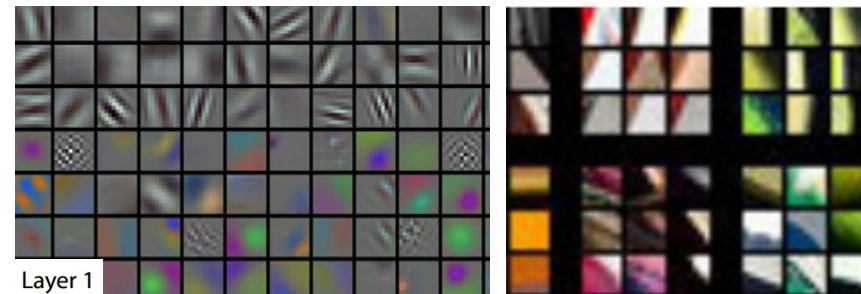
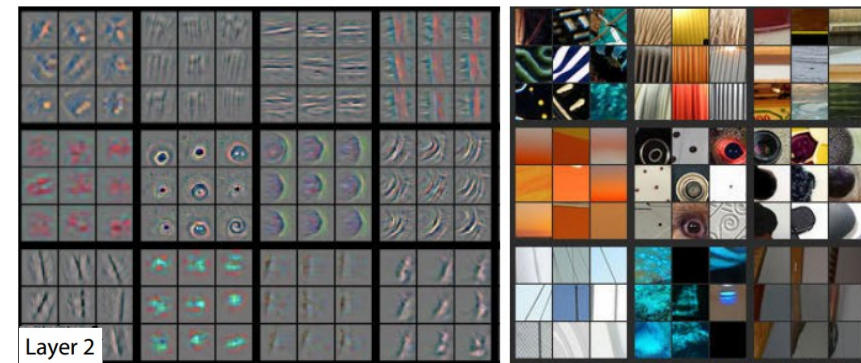
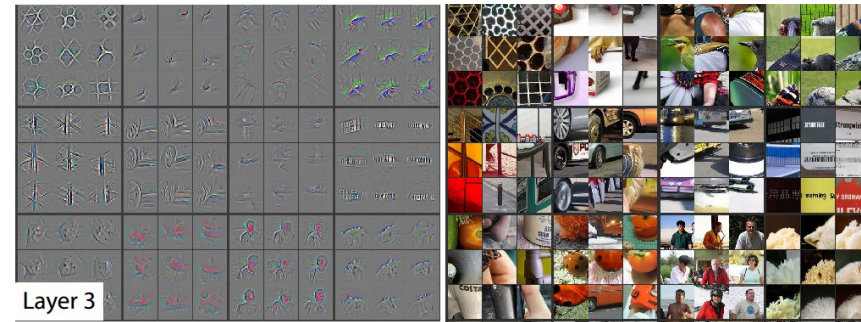

Zeiler and Fergus (2013)

Neural word vectors - visualization



Representations at NLP Levels: Syntax

- Traditional: Phrases
Discrete categories like NP, VP

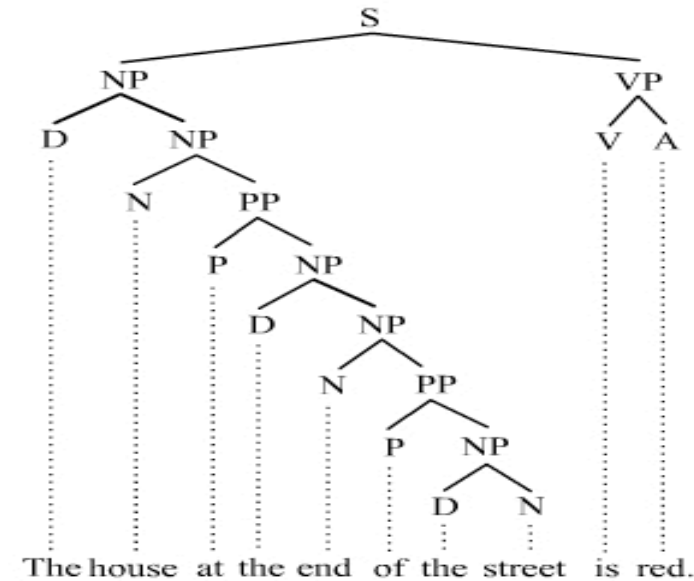

- DL:
 - Every word and every phrase is a vector
 - a neural network combines two vectors into one vector
 - Socher et al. 2011

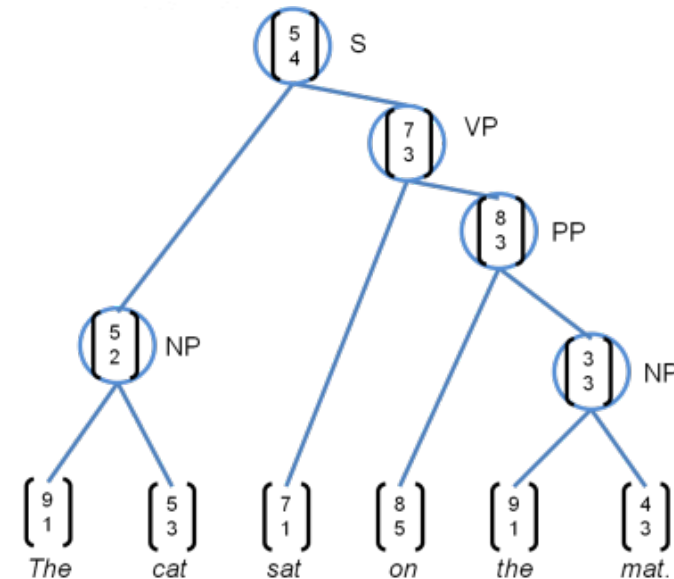

Machine Translation

- Many levels of translation have been tried in the past:
- Traditional MT systems are very large complex systems

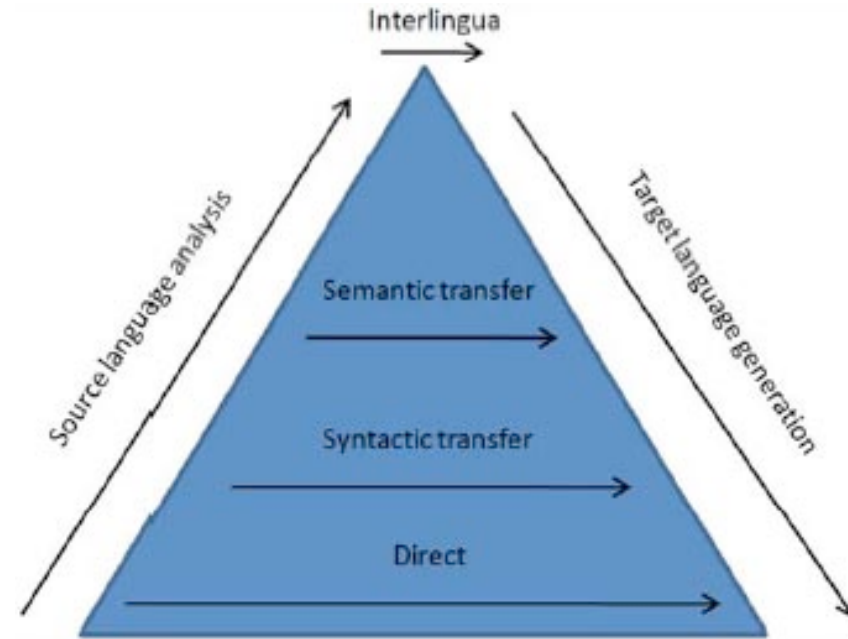
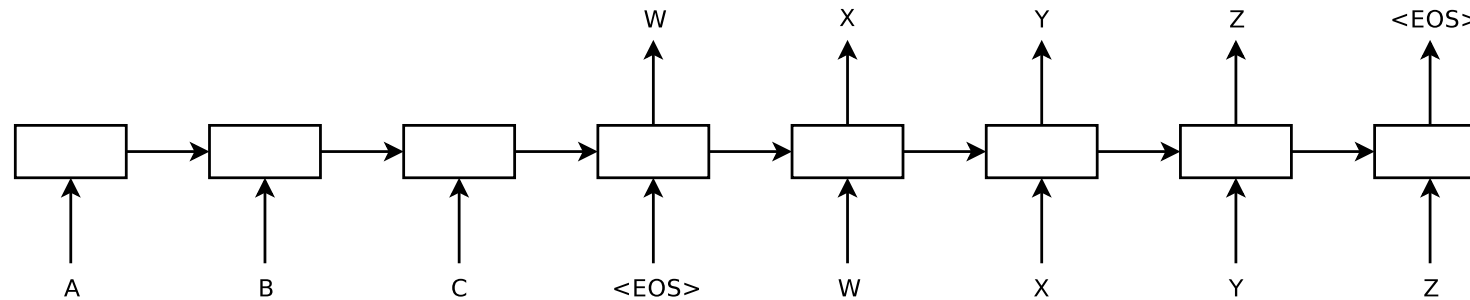

Figure 1: The Vauquois triangle

- What do you think is the interlingua for the DL approach to translation?

Machine Translation

- Source sentence mapped to vector, then output sentence generated.



- Sequence to Sequence Learning with Neural Networks by Sutskever et al. 2014
- Very new but could replace very complex architectures!

Perceptron

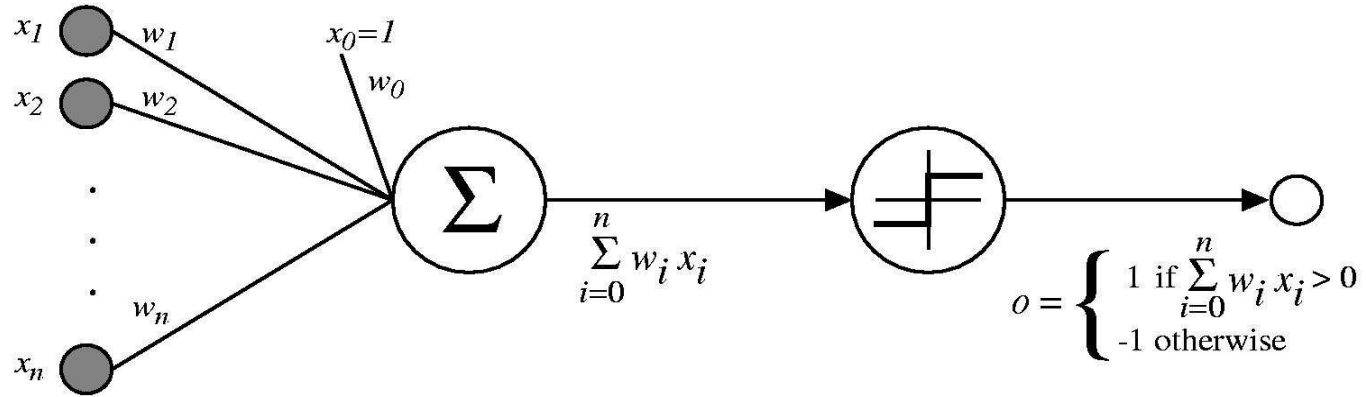

$$o(x_1, \dots, x_n) = \begin{cases} 1 & \text{if } w_0 + w_1 x_1 + \dots + w_n x_n > 0 \\ -1 & \text{otherwise.} \end{cases}$$

Sometimes we'll use simpler vector notation:

$$o(\vec{x}) = \begin{cases} 1 & \text{if } \vec{w} \cdot \vec{x} > 0 \\ -1 & \text{otherwise.} \end{cases}$$

Neural Nets for the Win!

- Neural networks can learn much more complex functions and nonlinear decision boundaries!

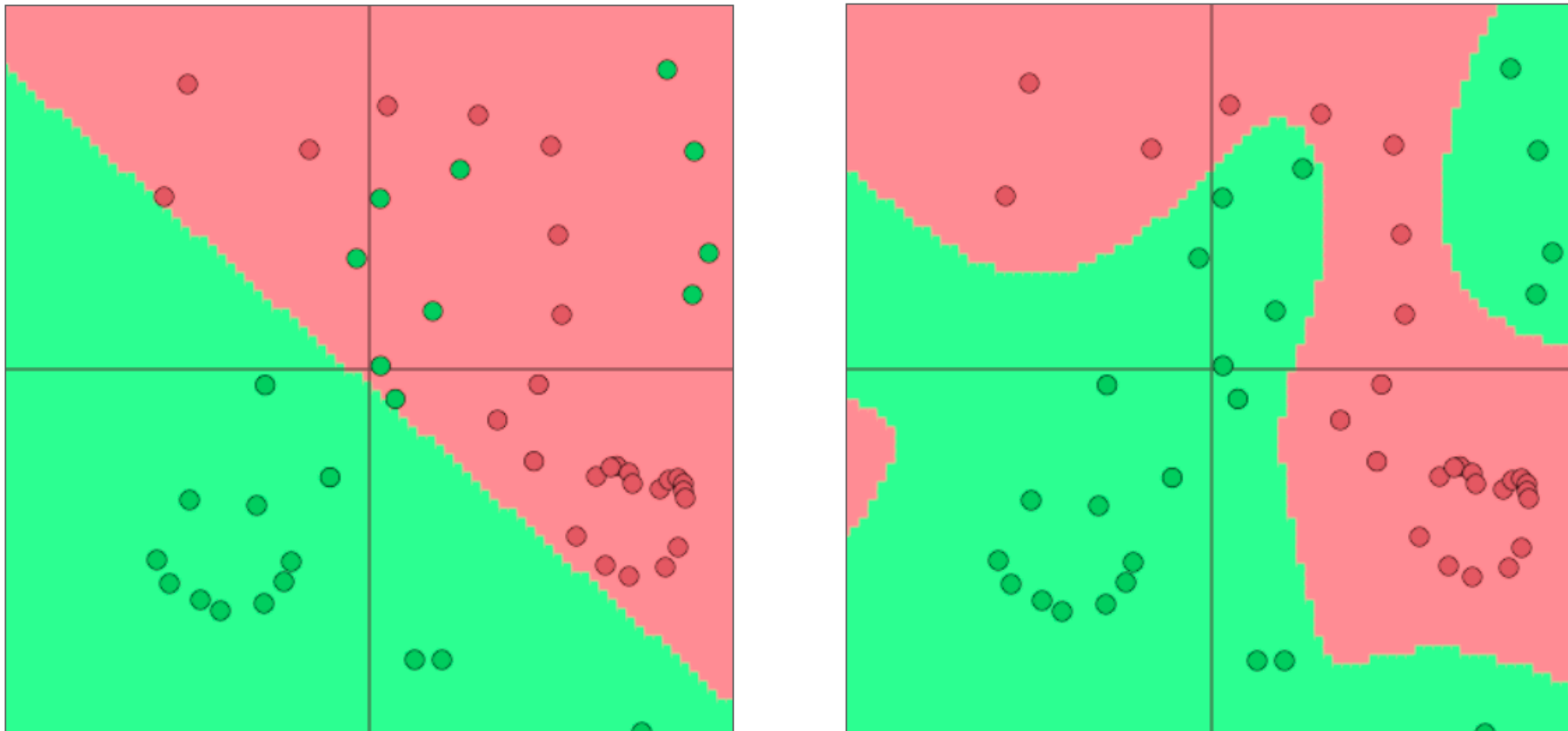

Multilayer Networks of Sigmoid Units

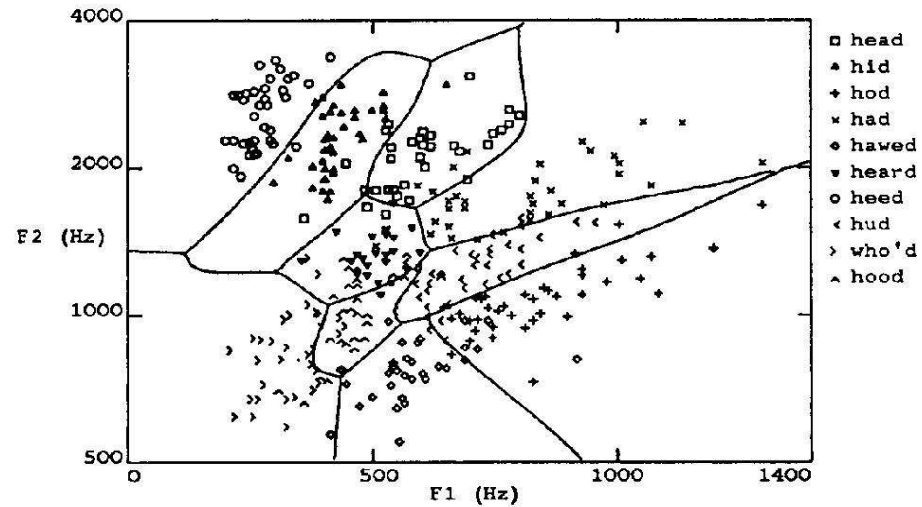
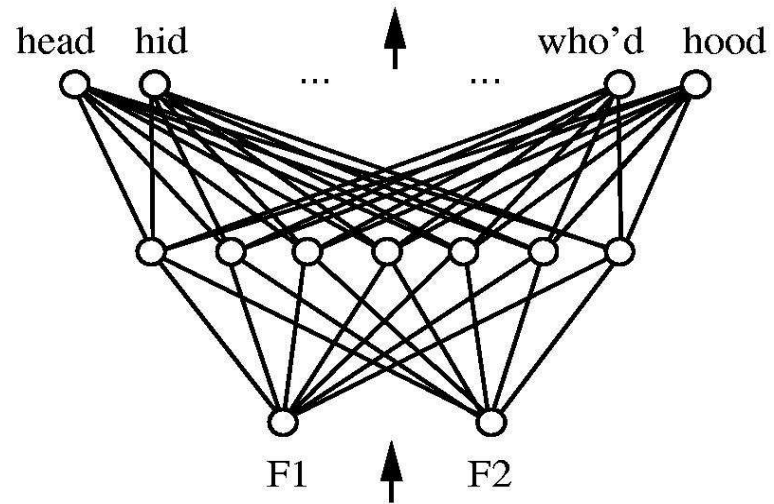

Sigmoid Unit

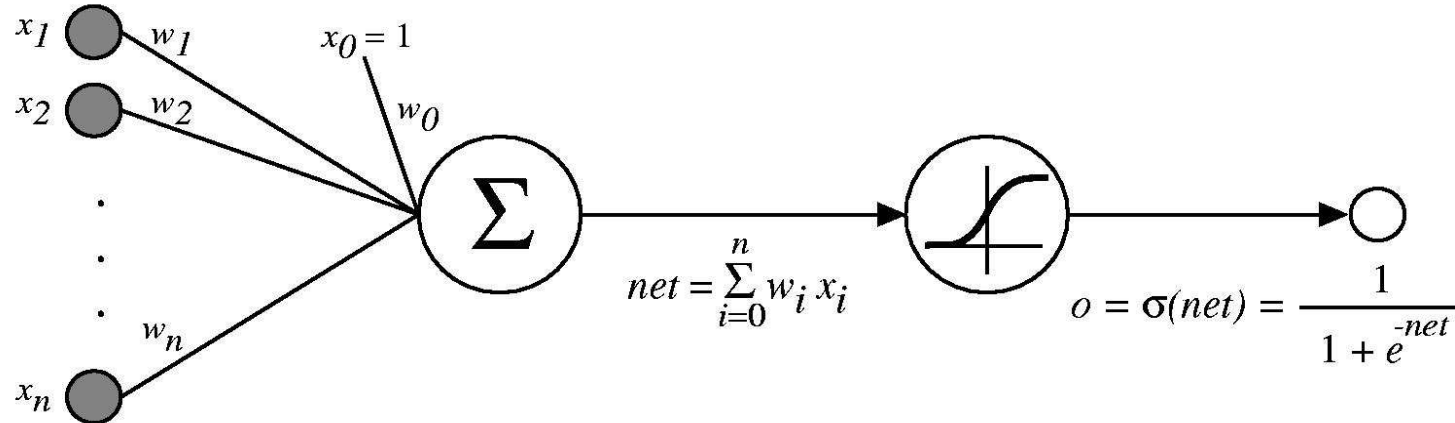

$\sigma(x)$ is the sigmoid function

$$\frac{1}{1 + e^{-x}}$$

Nice property: $\frac{d\sigma(x)}{dx} = \sigma(x)(1 - \sigma(x))$

We can derive gradient descent rules to train

- One sigmoid unit
- *Multilayer networks* of sigmoid units →
Backpropagation

Automatic Differentiation

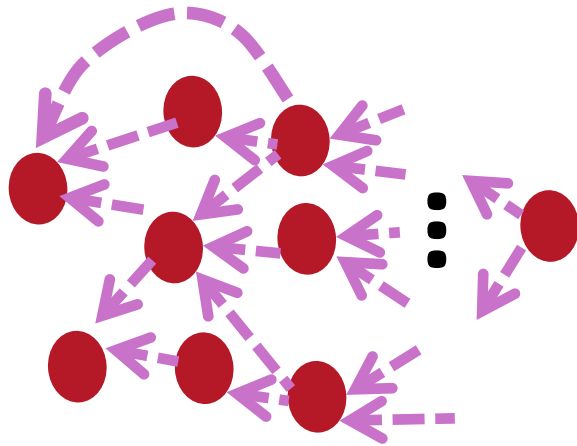
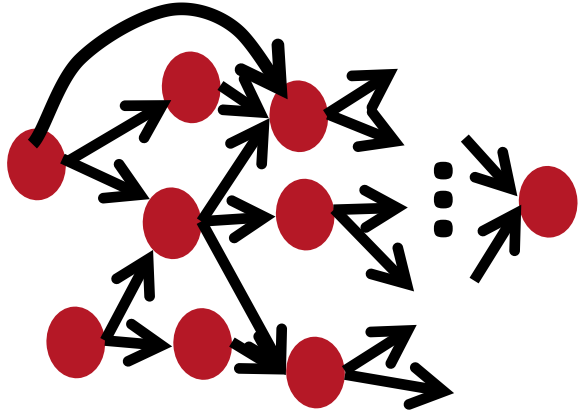

- The gradient computation can be **automatically inferred** from the symbolic expression of the fprop.
- Each node type needs to know how to compute its output and how to compute the gradient wrt its inputs given the gradient wrt its output.
- Easy and fast prototyping

Review

- Deep Learning
 - Learning Representations of Inputs
- Neural Networks
 - Layers of Logistic Regression
 - Can represent any nonlinear function (with a large enough network)
 - Training with backpropagation
- Recent breakthroughs in predictive tasks
 - Speech Recognition
 - Object Recognition (computer vision)

Neural Network Language Models

Q: How to model sequences with neural networks?

- Fixed number of inputs.

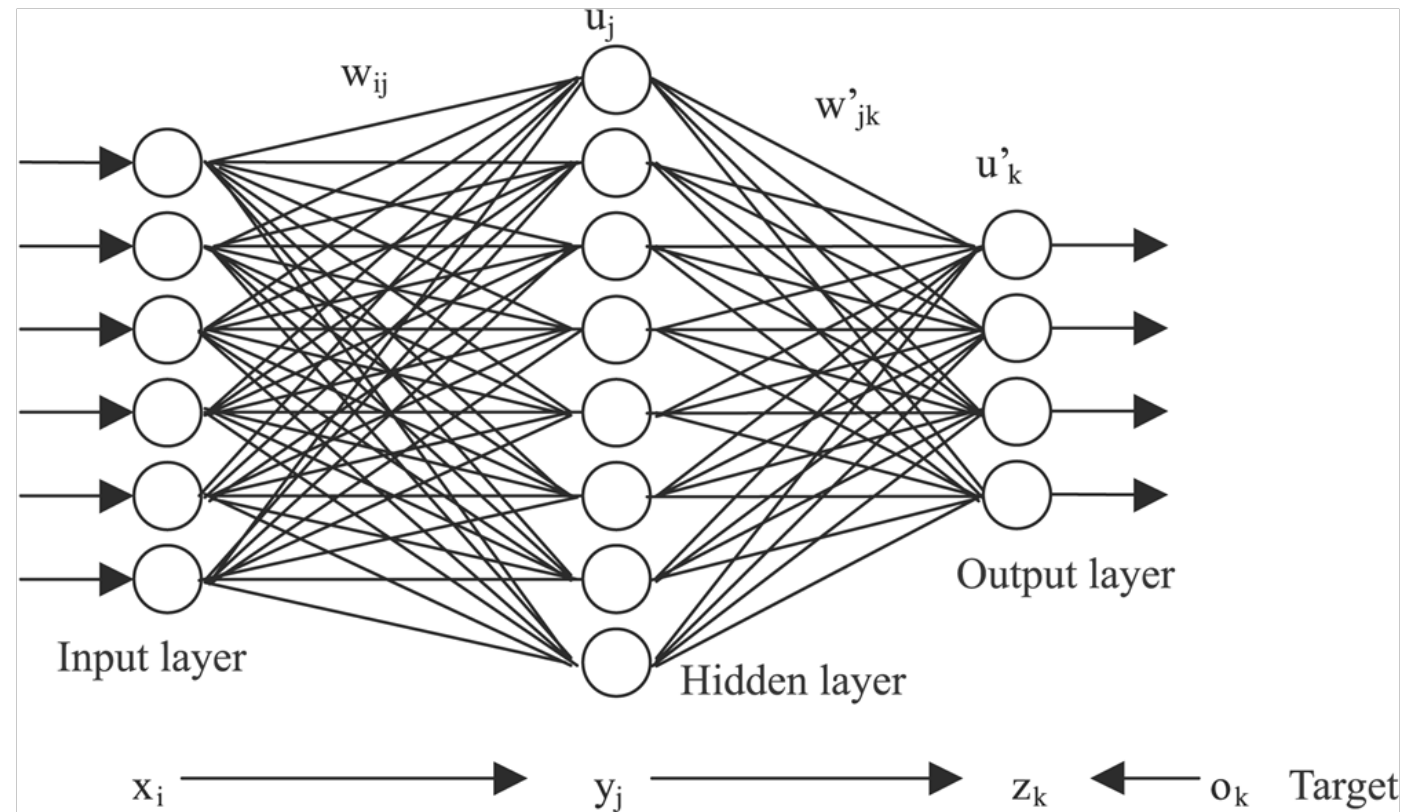

How about just predicting the next word in the input?

- Q: what about just predicting the next word?
- From the context?
 - No longer a language model
- Word2Vec!

Word2vec

- Learn continuous word embedding for each word
 - Each word represented by a vector

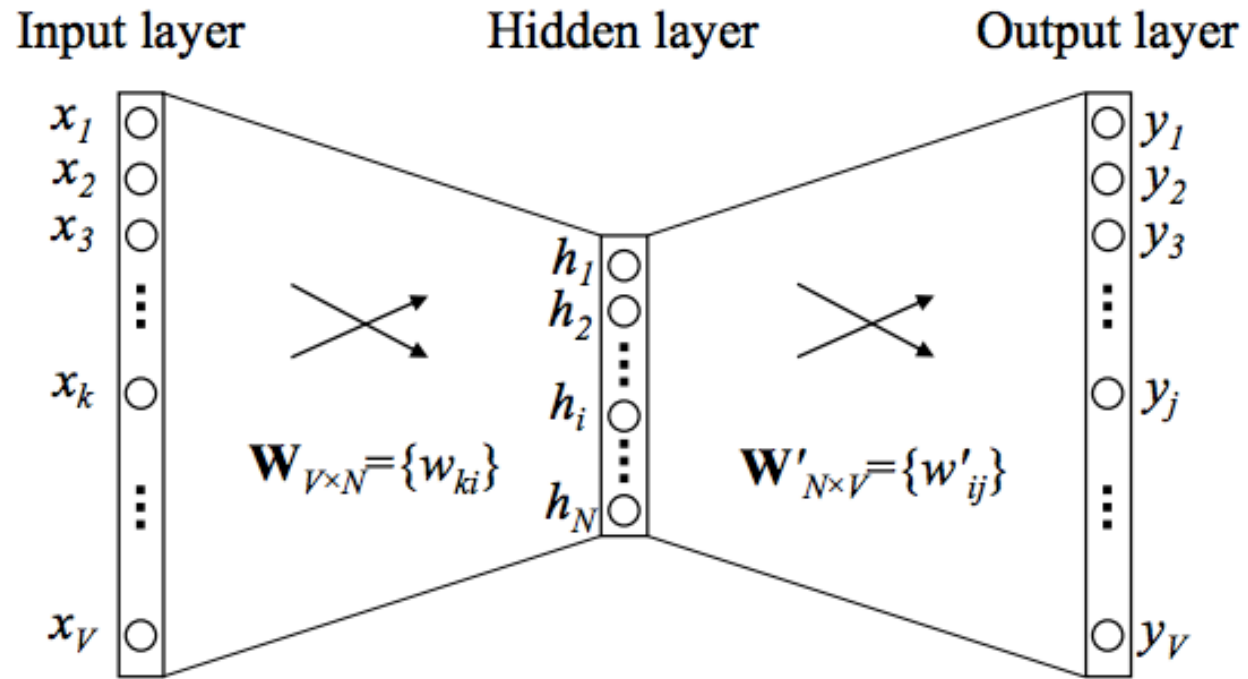

Figure 1: A simple CBOW model with only one word in the context

Using more than one word of context

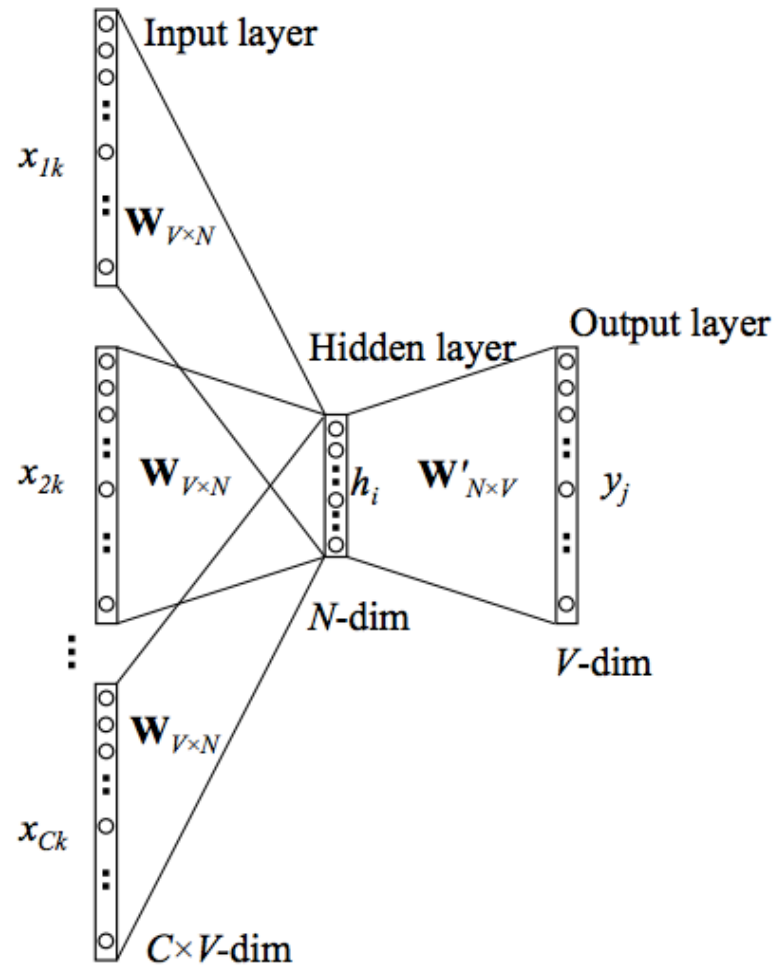

Figure 2: Continuous bag-of-words model

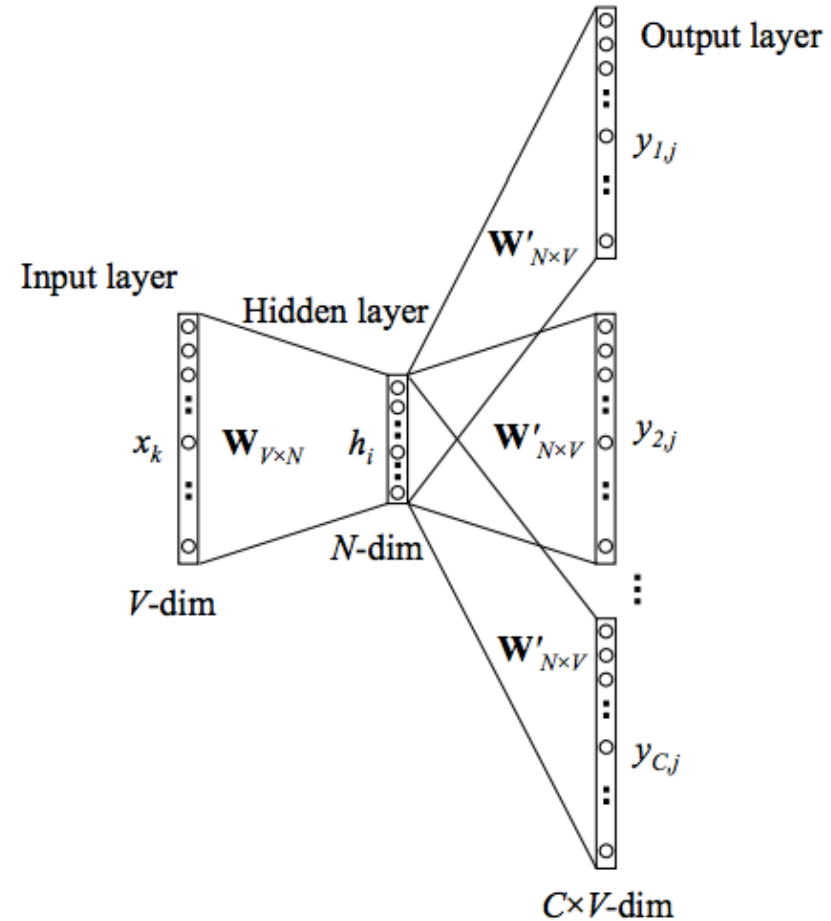
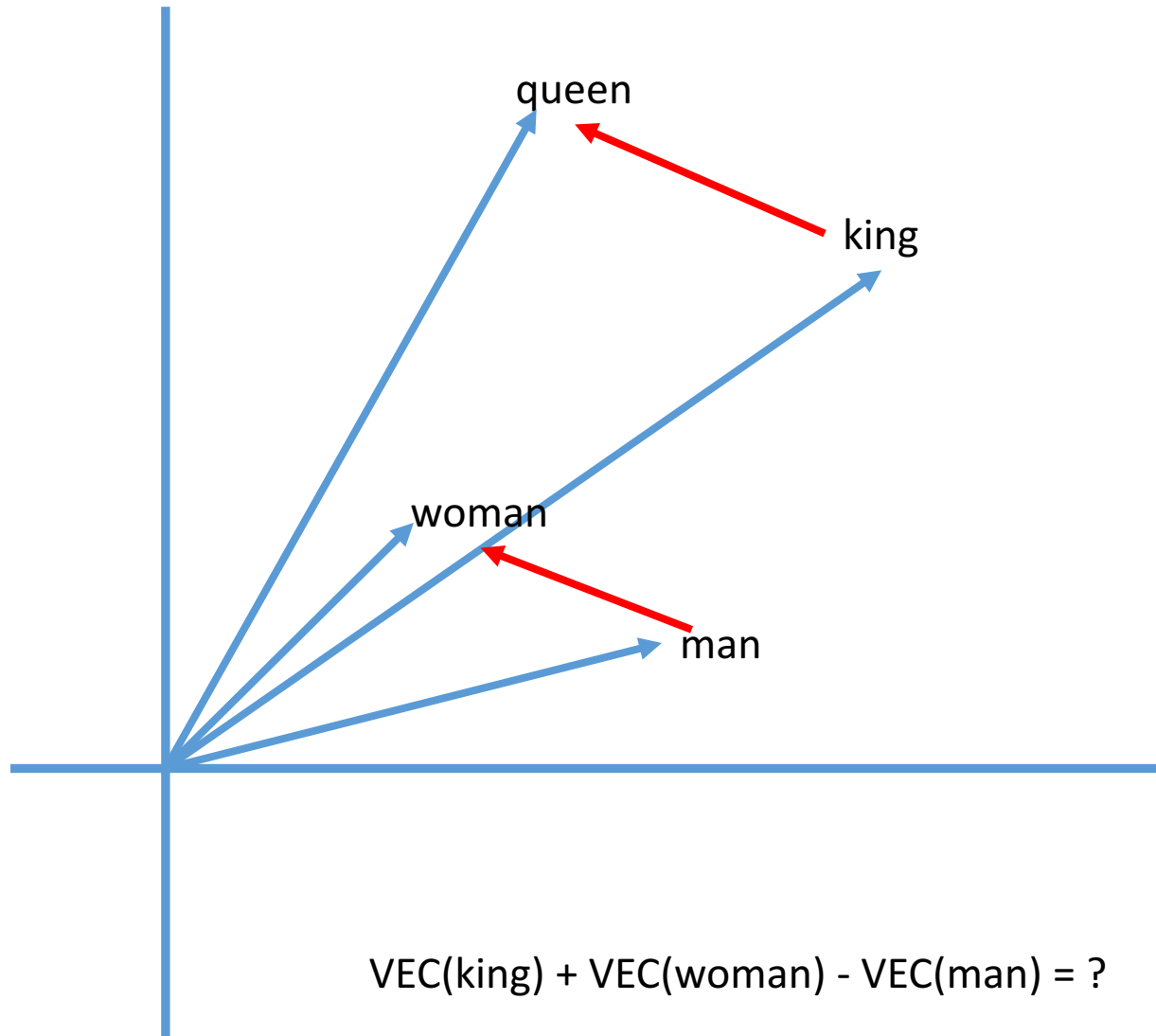

Figure 3: The skip-gram model.

Word2Vec: fast to train

- Word2Vec is a fairly simple model,
- But Can efficiently train word vectors on really big corpora
- This is probably the main advantage of Word2vec over other approaches...
 - Principal Component Analysis
 - Recurrent Neural Network Language Models



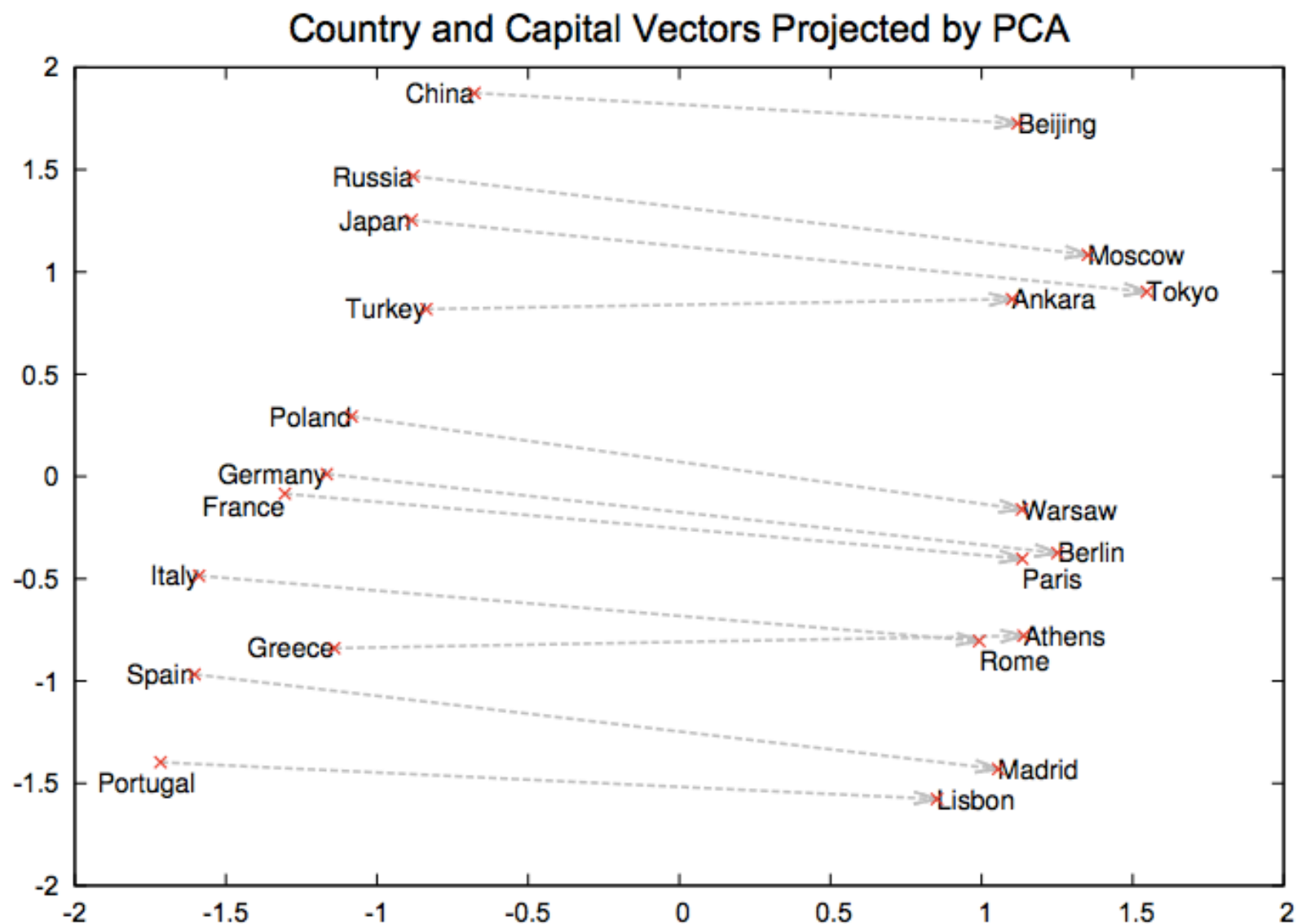

Figure 2: Two-dimensional PCA projection of the 1000-dimensional Skip-gram vectors of countries and their capital cities. The figure illustrates ability of the model to automatically organize concepts and learn implicitly the relationships between them, as during the training we did not provide any supervised information about what a capital city means.

The Unreasonable Effectiveness of Word Representations for Twitter Named Entity Recognition

Colin Cherry and Hongyu Guo
National Research Council Canada
first.last@nrc-cnrc.gc.ca

System	Fin10Dev	Rit11	Fro14	Avg
CoNLL	27.3	27.1	29.5	28.0
+ Brown	38.4	39.4	42.5	40.1
+ Vector	40.8	40.4	42.9	41.4
+ Reps	42.4	42.2	46.2	43.6
Fin10	36.7	29.0	30.4	32.0
+ Brown	59.9	53.9	56.3	56.7
+ Vector	61.5	56.4	58.4	58.8
+ Reps	64.0	58.5	60.2	60.9
CoNLL+Fin10	44.7	39.9	44.2	42.9
+ Brown	54.9	52.9	58.5	55.4
+ Vector	58.9	55.2	59.9	58.0
+ Reps	58.9	56.4	61.8	59.0
+ Weights	64.4	59.6	63.3	62.4

Table 5: Impact of our components on Twitter NER performance, as measured by F1, under 3 data scenarios.

Neural Translation Models (sequence to sequence)

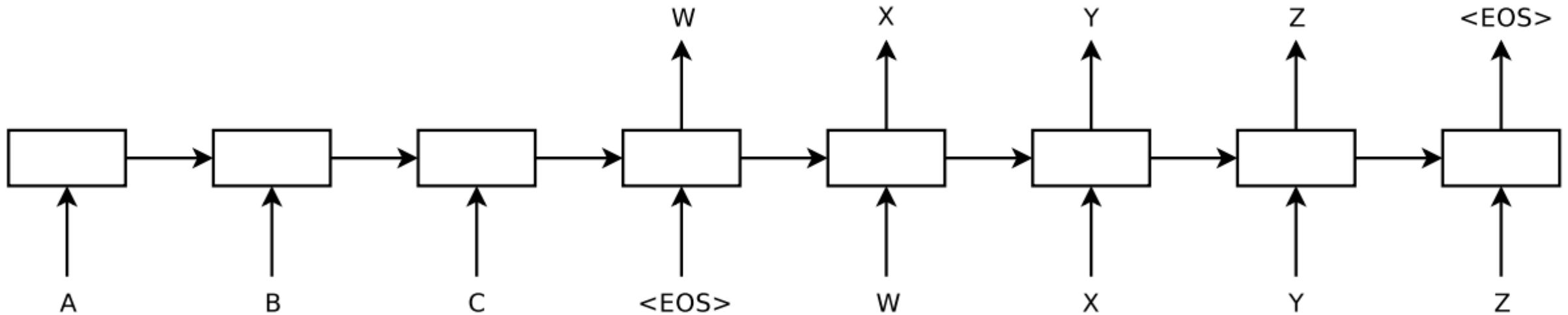

Conversation Generation

Human: *what is the purpose of life?*

Machine: *to serve the greater good.*

Human: *what is the purpose of living?*

Machine: *to live forever.*

Human: *what is the purpose of existence?*

Machine: *to find out what happens when we get to the planet earth.*

Human: *where are you now?*

Machine: *i'm in the middle of nowhere.*

Human: *what is the purpose of dying?*

Machine: *to have a life.*

Human: *what is the purpose of being intelligent?*

Machine: *to find out what it is.*

Human: *what is the purpose of emotions?*

Machine: *i don't know.*



Google Research Blog

Computer, respond to this email.

Tuesday, November 03, 2015

Posted by Greg Corrado*, Senior Research Scientist

Machine Intelligence for You

What I love about working at Google is the opportunity to harness cutting-edge machine intelligence for users' benefit. Two recent Research Blog posts talked about how we've used machine learning in the form of [deep neural networks](#) to improve [voice search](#) and [YouTube thumbnails](#). Today we can share something even wilder -- Smart Reply, a deep neural network that writes email.

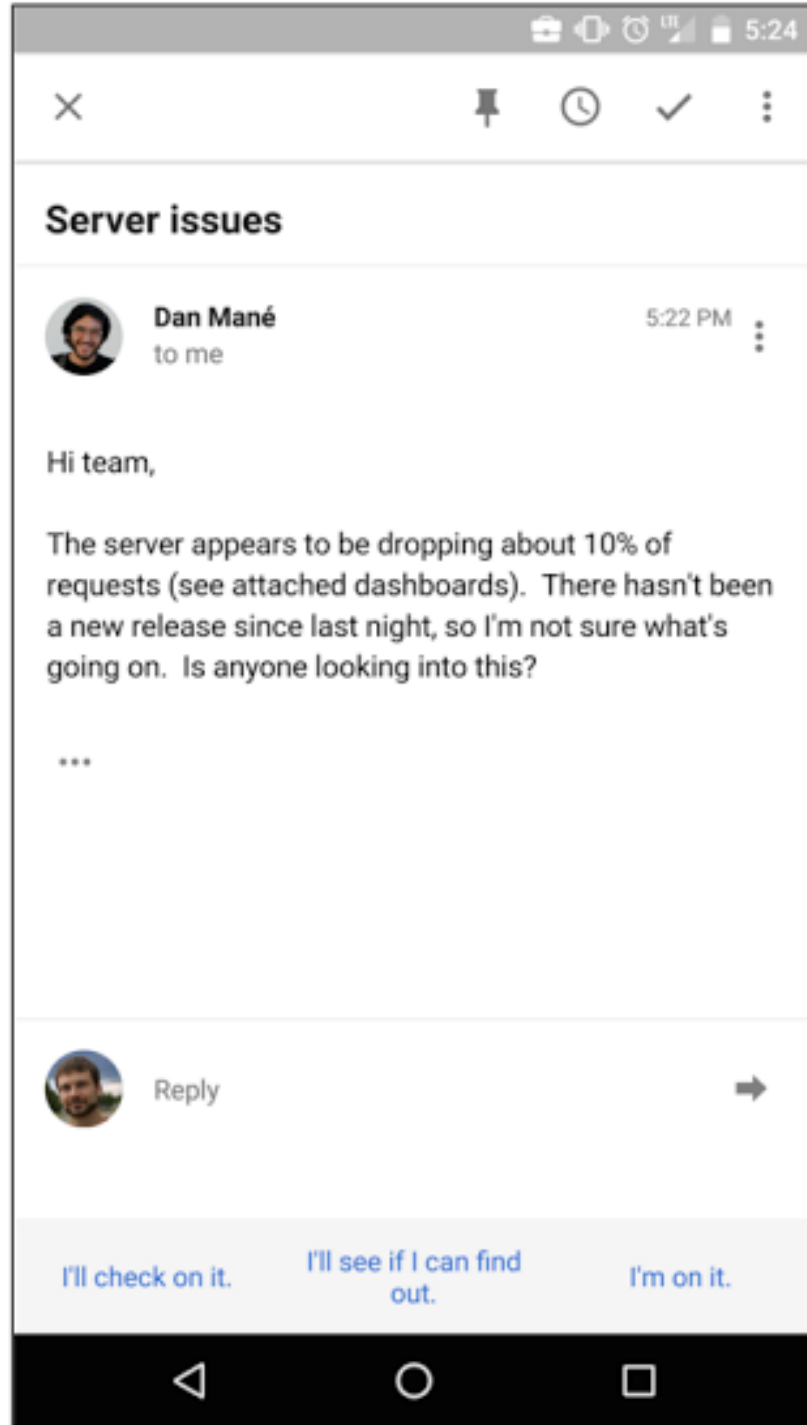
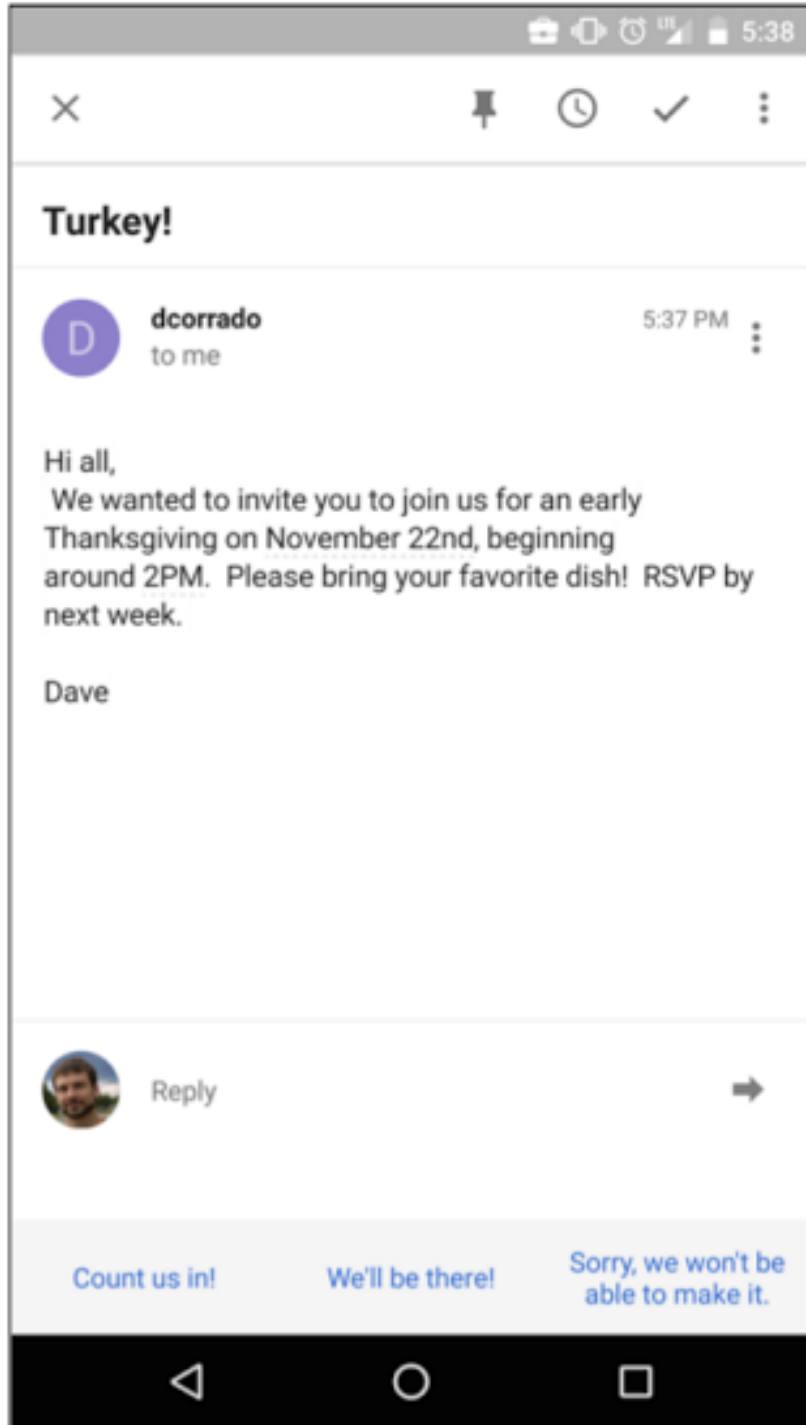

Show and Tell: A Neural Image Caption Generator

Oriol Vinyals
Google

`vinyals@google.com`

Alexander Toshev
Google

`toshev@google.com`

Samy Bengio
Google

`bengio@google.com`

Dumitru Erhan
Google

`dumitru@google.com`



[Krizhevsky, Sutskever, Hinton. 2012] 16.4% error

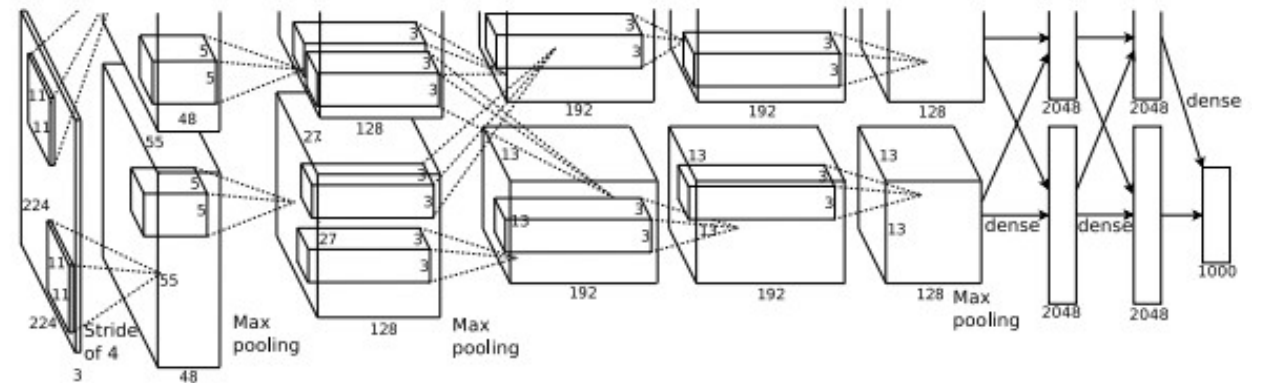
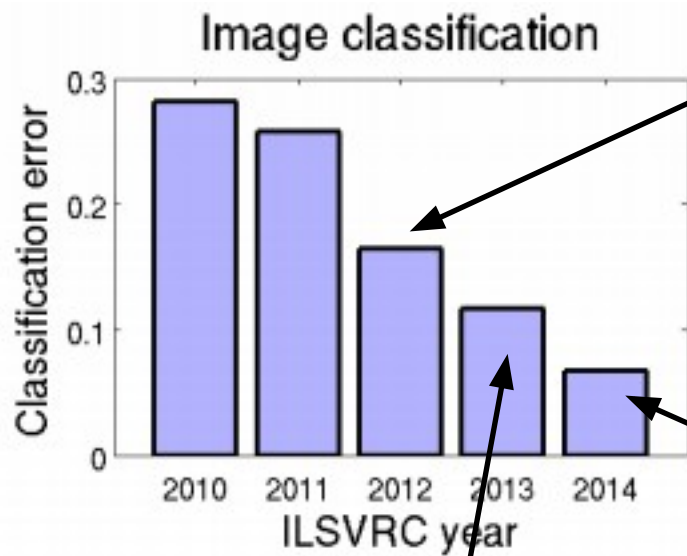

[Szegedy et al., 2014] 6.6% error

[Simonyan and Zisserman, 2014] 7.3% error

[Zeiler and Fergus, 2013] 11.1% error

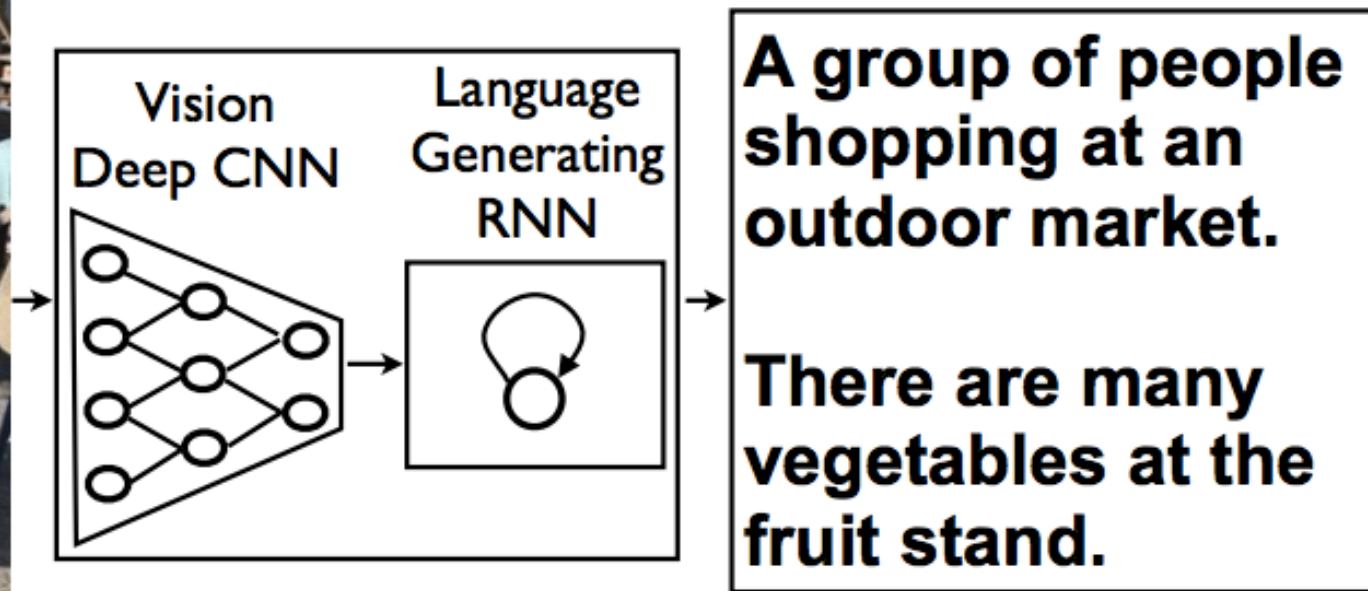

Figure 1. NIC, our model, is based end-to-end on a neural network consisting of a vision CNN followed by a language generating RNN. It generates complete sentences in natural language from an input image, as shown on the example above.

Image Sentence Datasets

a man riding a bike on a dirt path through a forest.
bicyclist raises his fist as he rides on desert dirt trail.
this dirt bike rider is smiling and raising his fist in triumph.
a man riding a bicycle while pumping his fist in the air.
a mountain biker pumps his fist in celebration.



Microsoft COCO
[Tsung-Yi Lin et al. 2014]
mscoco.org

currently:
~120K images
~5 sentences each

Summary of the approach

We wanted to describe images with sentences.

1. Define a single function from input -> output
2. Initialize parts of net from elsewhere if possible
3. Get some data
4. Train with SGD

Wow I can't believe that worked



a group of people standing
around a room with
remotes
logprob: -9.17



a young boy is holding a
baseball bat
logprob: -7.61



a cow is standing in the middle of a street
logprob: -8.84

Wow I can't believe that worked



a cat is sitting on a toilet seat
logprob: -7.79



a display case filled with lots of different types of donuts
logprob: -7.78



a group of people sitting at a table with wine glasses
logprob: -6.71

Well, I can kind of see it



a man standing next to a clock on a wall
logprob: -10.08



a young boy is holding a
baseball bat
logprob: -7.65



a cat is sitting on a couch with a remote control
logprob: -12.45

Summary

- Deep learning is a popular area in machine learning recently
 - Very successful in speech recognition and computer vision
- Becoming very popular in NLP these days
- Main motivation:
 - Learn feature representations from data
 - Alternative to hand-engineered features
- Neural networks:
 - Primary deep learning approach
 - Layers of logistic regressions – can directly calculate gradients from outputs
 - Nonlinear decision boundaries