

Neocortex

- Shepherd (2004) Chapter 12
- Rodney Douglas, Henry Markram, and Kevan Martin
- Instructor: Yoonsuck Choe; CPSC 644 Cortical Networks

1

Neocortex Facts

- 2 mm thick, 6 layers.
- 50,000 neurons packed in 1 mm³.
- Global surveys: cytoarchitectonics, myeloarchitectonics
- Cytoarchitectonic divisions:
 - Koniocortex (granular cortex): sensory area; small densely packed neurons in the middle layer.
 - Agranular cortex: motor and premotor area; no packed neurons in the middle layer (granular layer largely absent).
 - Eulaminate/Homotypical: association cortex;

3

Cortical Structures in the Brain

“Bark-like” (cortical) structures:

- Neocortex: most recent arrival in evolutionary history; more pronounced, along with cerebellum, in human than any other species; neocortex plus connections take up 80% of brain volume in humans.
- Archicortex: hippocampus
- Paleocortex: olfactory bulb and olfactory cortex

2

Laminar Organization

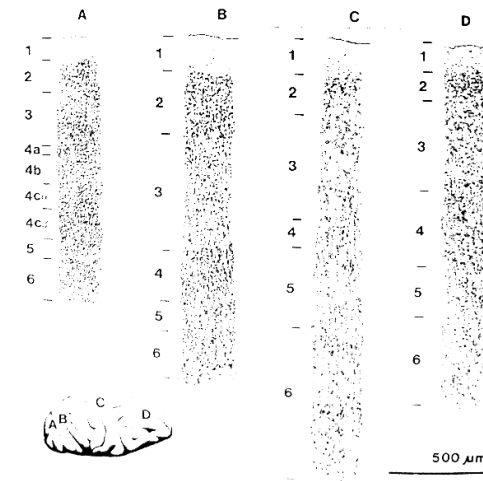

A: V1, B: V2, C: M1, D: Area 9 (frontal)

4

Map of the Neocortex

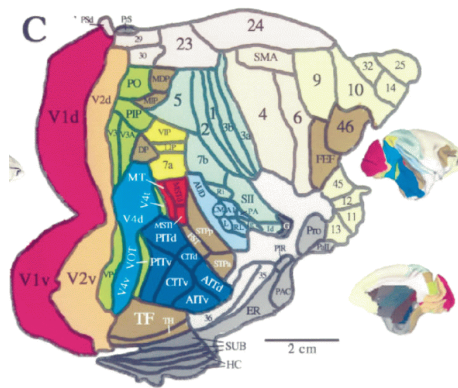

Van Essen and Drury, *J. Neurosci*, 1997

- Map of human visual areas.

5

Development of the Nervous System

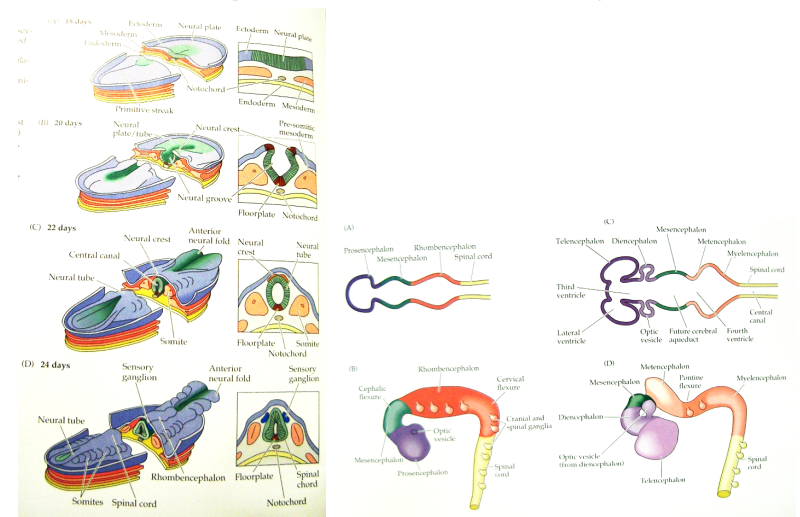

From Purves et al. (1997)

6

Embryonic Development of Neocortex

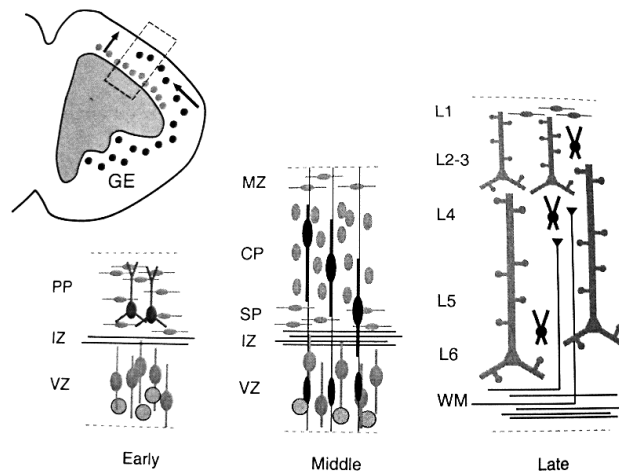

GE (ganglionic eminences); VZ (ventricular zone); IZ (intermediate zone); PP (preplate); SP (deep subplate); CP (cortical plate); MZ (marginal zone); WM (white matter)

Neuronal Elements

- Ramon y Cajal's ground-breaking studies 100 years ago: silver impregnation method (Golgi) to study neurons and circuits.
- Two types of neurons: Spiny (stellate and pyramidal cells) and smooth (smooth cells; basket cells).

8

Spiny Neurons

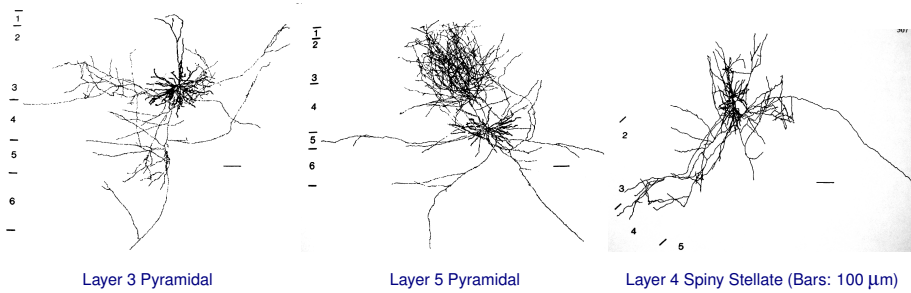

Neurons with dendritic spines ($1 \mu\text{m}$ bulge, $0.1 \mu\text{m}$ neck).

- Pyramidal neurons: 2/3 of neurons in the neocortex. Major output neuron. Apical dendrite. Long-range projections (from layer 5). Local excitation.
- Spiny stellate neurons: in layer 4 of the granular cortex. No apical dendrite. Mostly local. Major recipient of thalamic input.

9

Afferents to the Neocortex

- Thalamus: 5% to 10% of all afferents to the neocortex. Highly ordered. Magnification factor (dense sensory receptor area maps to larger portion of cortex). Barrels in rats/mice.
- Subcortical regions: claustrum, locus coeruleus, basal forebrain, dorsal and medial raphe, pontine reticular system, etc.
- Corticocortical connections: majority of fibers in the white matter. Projecting to layer 4 (feedforward). Projecting to non-layer 4 (feedback). **All cortical areas are mutually connected.**

11

Smooth Neurons

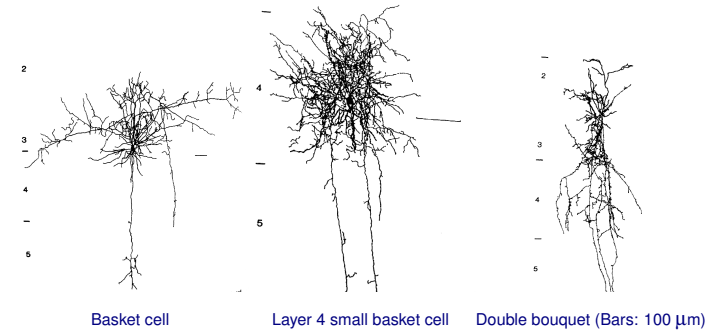

Neurons with smooth dendrites.

- Basket cell in the cerebellum and hippocampus. Projections from basket cells form basket-like enclosure on target neuron's soma (pyramidal cell, etc.). Projections typically extend laterally.
- Double bouquet cell: vertically extended dendritic arbor. axon also forms vertical collaterals.

10

Synaptic Connections

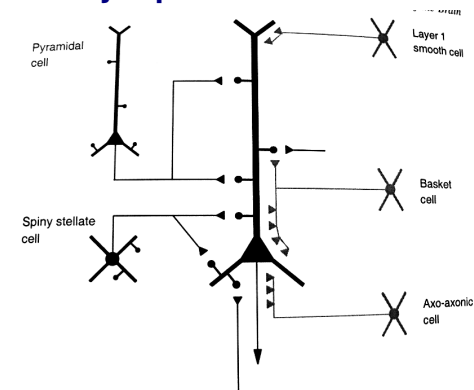

Black: pyramidal (excitatory); Gray: smooth (inhibitory)

- Type 1: small round vesicles – often excitatory; Type 2: small flat vesicles – often inhibitory.
- Spiny: type 1 (84 %); Smooth: type 2 (16%).

12

Synaptic Connections (Cont'd)



Top: Small basket cell; Bottom: spiny stellate cell; Bar: 10 μm

- Spiny neuron axons: major source of input to cortical neurons. Only 10% is from thalamic relay (in layer 4).
- Smooth neuron: inhibitory. basket cell forms 20% of all GABAergic neurons. Local projections.

13

Firing Modes

- Fast spiking: smooth cells (GABAergic)
- Regular firing: pyramidal cells with adapting pattern of discharge – predominant type. Some smooth cells show this kind of firing.
- Bursting: pyramidal cells – mostly in deep layers.
- Chattering cells: kind of bursting.

15

Basic Circuit

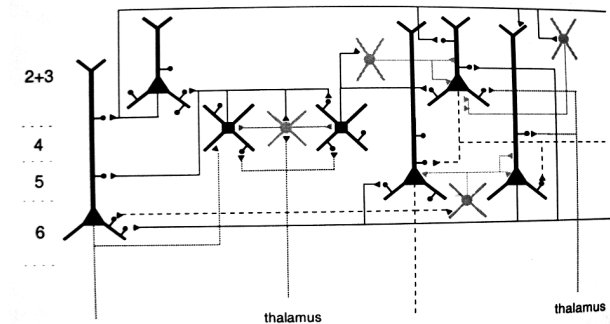

Cortical output: mostly pyramidal neurons (they also receive thalamic afferents).

- Corticocortical projection: from superficial layers
- Subcortical projection: from deep layers. To basal ganglia, SC, brainstem nuclei, spinal cord, and thalamus.

14

Functional Operations

- Cortical activation is thought to “describe the world”.
- “However, the nature of the encoding used by the neurons to represent the world is still a matter of intense and interesting debate.”
- “The encoding problem is important because it determines ... the success with which the nervous system can interact with the world. It is clear that the attributes of the world must be encoded in the variables of the nervous system.”
- “One central question is whether the nervous system uses a data representation in which the encoding of objects is distributed ... or ... localized.”

YC: Are these really well-formed questions/views?

16

Canonical Cortical Circuit

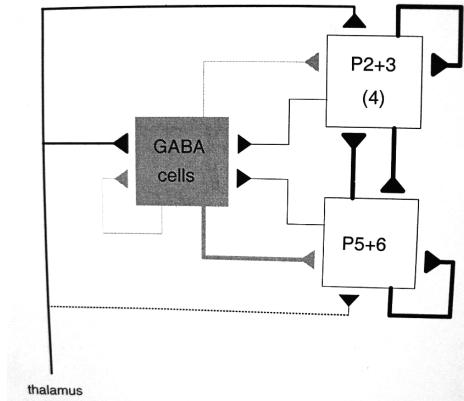

- Some dominant components and connections are shown.