

Computational Maps in the Visual Cortex

Risto Miikkulainen

Department of Computer Sciences
and Institute for Neuroscience
The University of Texas at Austin

Joint work with Jim Bednar, Yoonsuck Choe, and Joseph Sirosh

Supported in part by NIMH 1R01-MH66991, NSF IIS-9811478 & IRI-9504317

Role of Computational Modeling

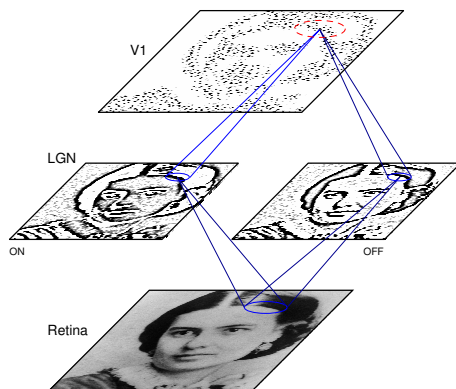

- Computational model is an artificial subject with full access
 - Test hypotheses computationally, make predictions
- Computational theory of the visual cortex
 - Build better artificial systems
 - Improve medical treatment

Understanding Vision

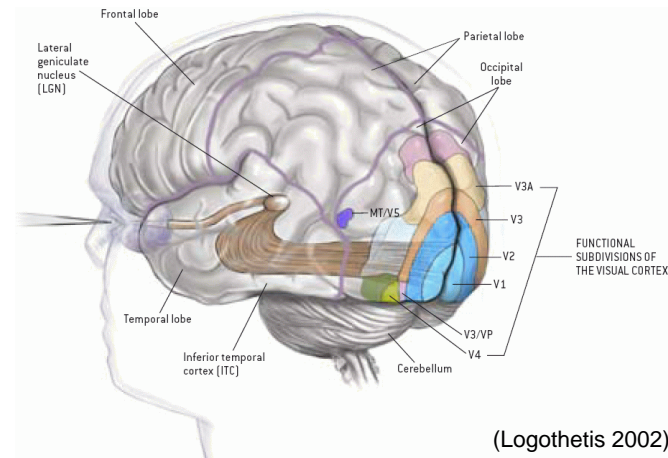

- How is a system as complex as the human visual system constructed?
- How can it be both genetically and environmentally determined?
- How does its structure support functions such as perceptual grouping?

Human Visual System

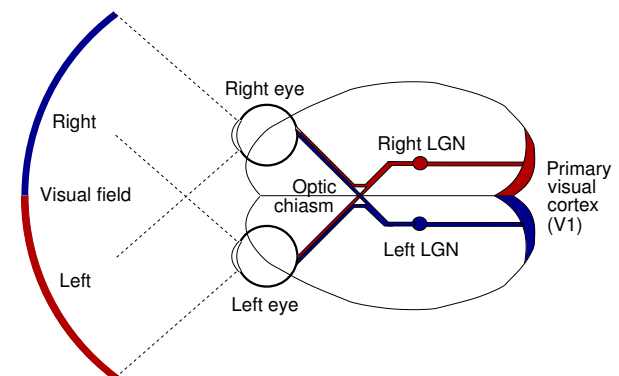

- Retina, LGN, V1...etc.
- Structure well known

Receptive Fields

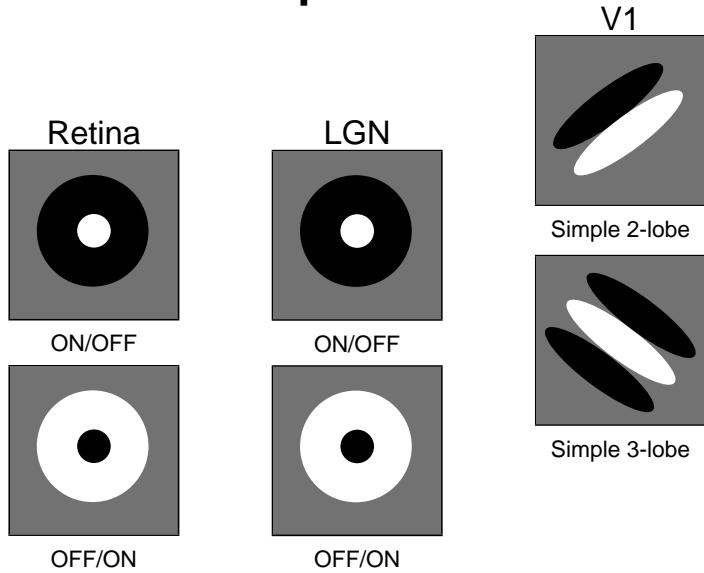

Spatiotemporal

- Center-surround; static and moving lines; combinations

Measuring Cortical Maps

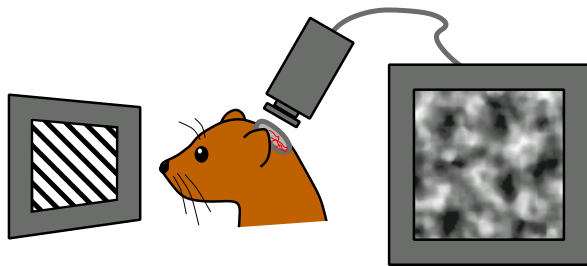

- Surface reflectance changes with activity
- Optical imaging can be used to detect

Columnar Organization of V1

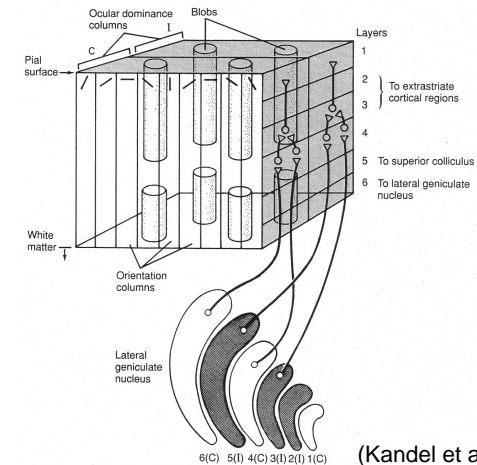

(Kandel et al. 1991)

- Roughly hierarchical ordering:
 - Retinotopy, OD, OR, DR
 - Color, spatial frequency, disparity?
- Within column, similar responses: 2D structure

Orientation Map

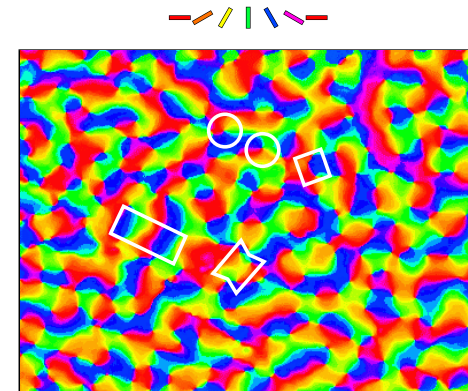

(7.5 mm × 5.5 mm in macaque V1; Blasdel, 1992)

- Preferences mapped systematically
- Linear zones, pinwheels, saddles, fractures

Orientation & Ocular Dominance Map

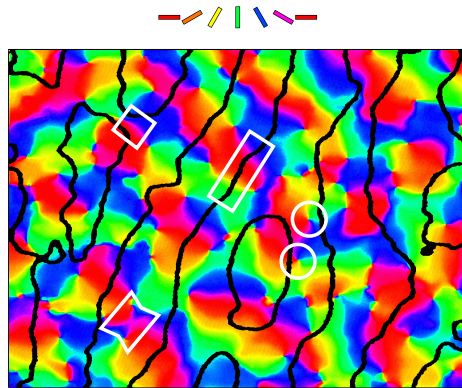

(4 mm × 3 mm in macaque V1; Blasdel, 1992)

- Systematic interactions
 - OD, OR boundaries at right angles
 - Pinwheels, saddles in the middle

Orientation & Direction Map

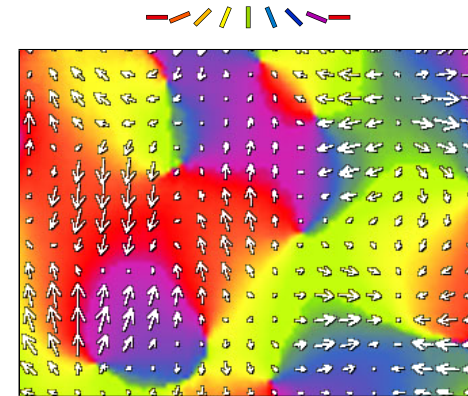

(1.4 mm × 1.1 mm in ferret V1; Weliky et al. 1996)

- Systematic interactions
 - OD, OR boundaries at right angles
 - OR patches contain opposite DR

Lateral Connections

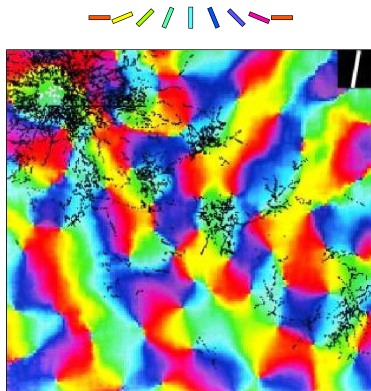

(2.5 mm × 2 mm in tree shrew V1; Bosking et al. 1997)

- Link to similar responses
- Patchy structure, extend along OR preference

Development



(4 mm × 3 mm OR+select in ferret V1; Chapman et al. 1996)

- Structure emerges during development
- Some prenatally, much postnatally
- How and why?

LISSOM Model

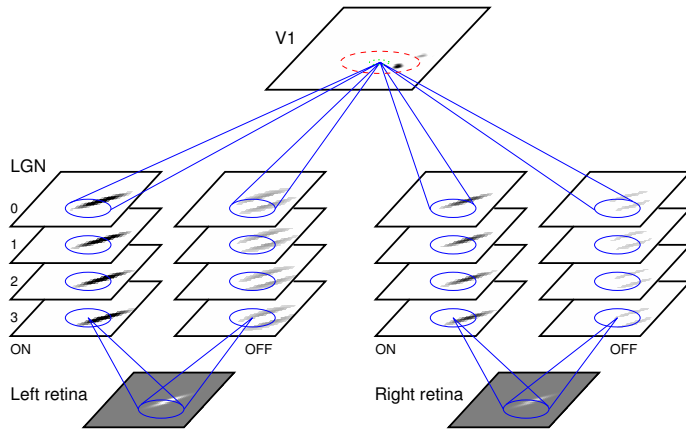

- Combined OR, OD, DR
- Retina, LGN, V1 (+ other areas)
- 2D sheets, afferent and lateral connections
- Hebbian learning in V1

Activation

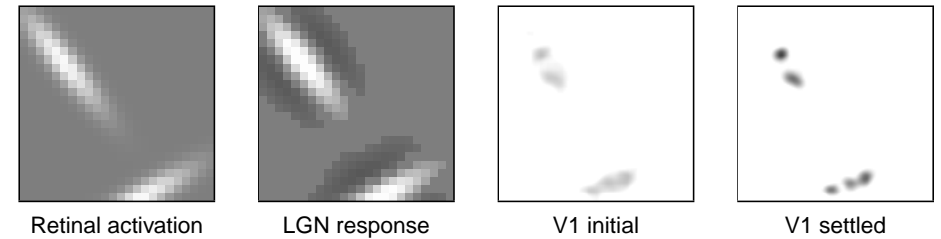

- Luminance adjustment in retina
- Sharpening in LGN (ON—OFF shown)
- Settling in V1:

$$\eta'_i = \sigma(\sum_k \chi_k A_{ki} + \sum_j \eta_j E_{ji} - \sum_j \eta_j I_{ji})$$

Adaptation

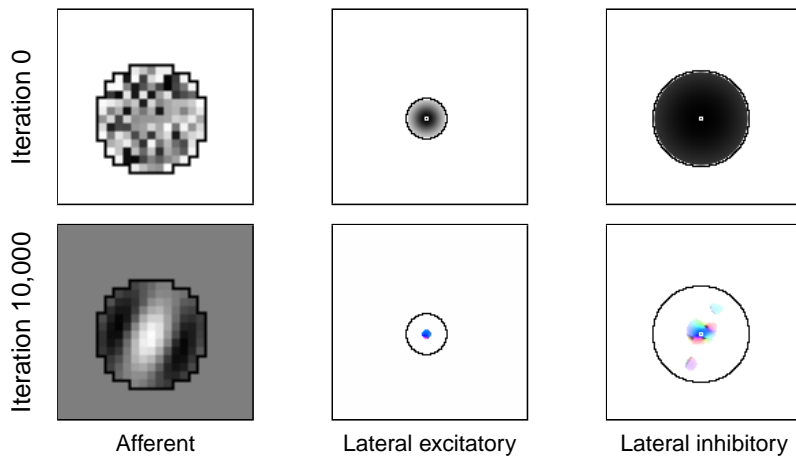

- Normalized Hebbian learning: $A'_{ki} = \frac{A_{ki} + \alpha \chi_k \eta_i}{\sum_{mn} (A_{kn} + \alpha \chi_k \eta_n)}$
→ Input-driven self-organization
- Pruning unused connections
- Results in realistic receptive fields, patchy lateral connections

Orientation Map

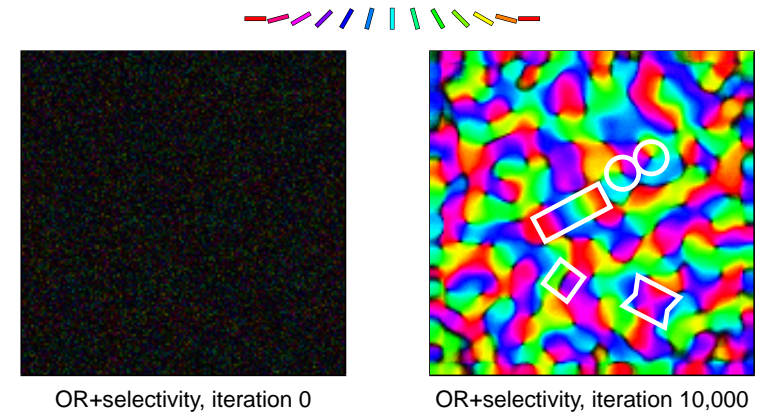

- Systematic preferences emerge
- Similar structures as in biology

Orientation & Ocular Dominance

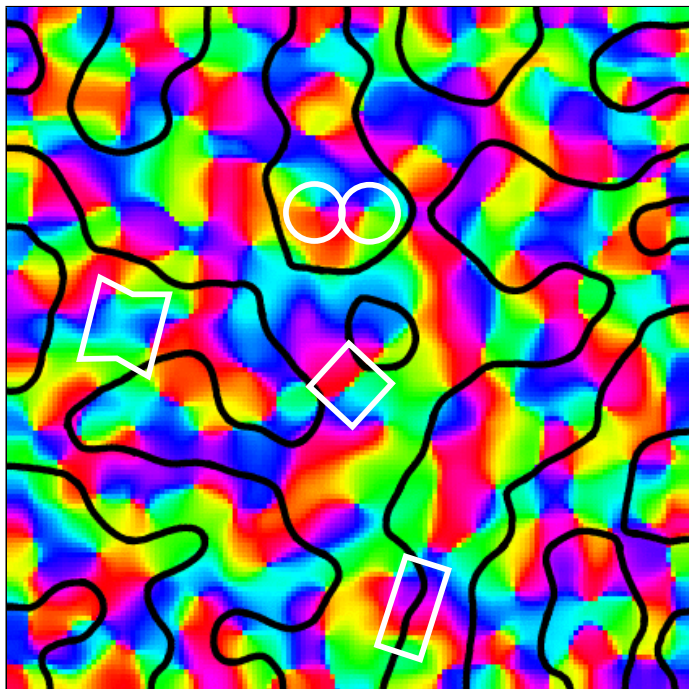

OR & OD & DR Map

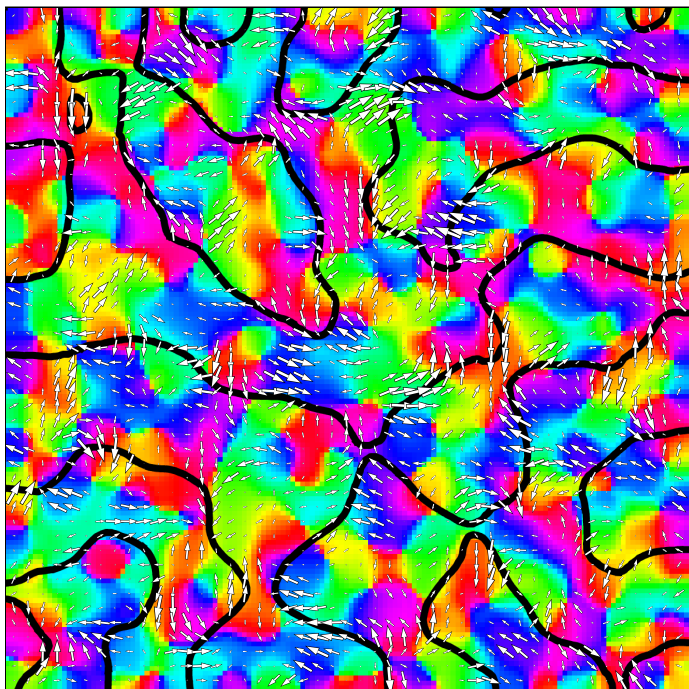

Orientation & Direction



Lateral Connections

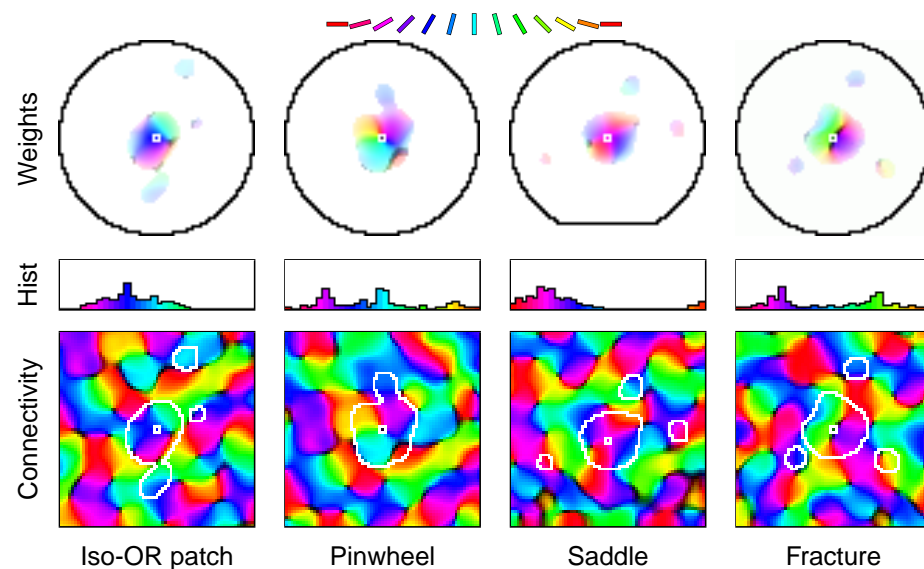

- Link similar responses
- OR primary factor
- Matches biology; detailed predictions

Self-Organization Conclusions

- How is V1 constructed?
 - Input-driven self-organization
- Predictions:
 - Input deprivation (e.g. strabismus)
 - Connection patterns
 - Plasticity
 - Illusions and aftereffects
 - Visual coding

What Is the Goal of Visual Coding?

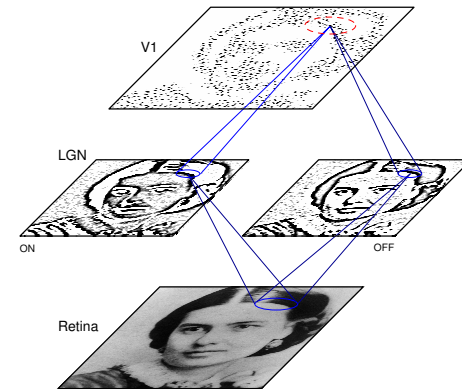

- Representing the important features of the input
- Efficient use of resources:
 - Can represent more information within a limited system

How is Such a Coding Constructed?

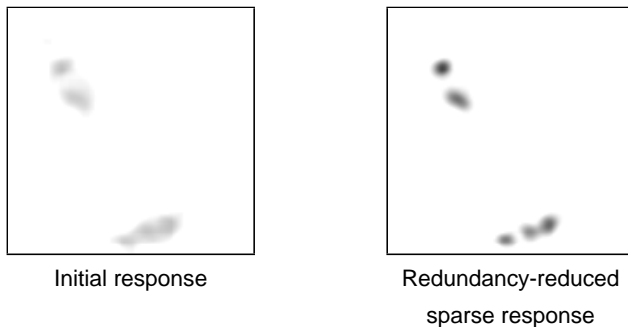

- Not by reducing units: V1 is much larger than the retina
- Could be a sparse code with few active units
- Need to make sparse by reducing redundancy
(Barlow 1972; Atick 1992; Field 1994; Simoncelli & Olshausen 2001)

Lateral Connection Hypothesis

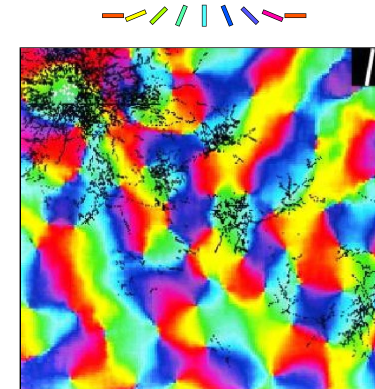

(2.5 mm × 2 mm in tree shrew V1; Bosking et al. 1997)

- Afferent connections respond to input features
- Inhibitory lateral connections *decorrelate* the response
 - Connect neurons that respond to similar inputs
 - Response of one neuron can be predicted from the other
 - Can be suppressed without losing information

Testing the Hypothesis

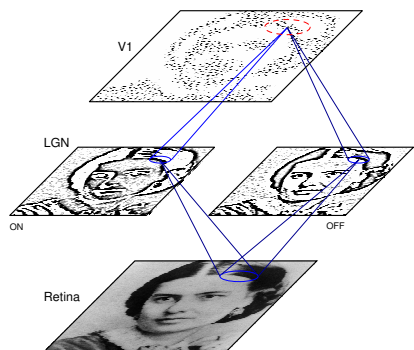

- Difficult to test experimentally
 - Requires many neurons, short time scales
- Can be tested in computational models

Does LISSOM Reduce Redundancy?

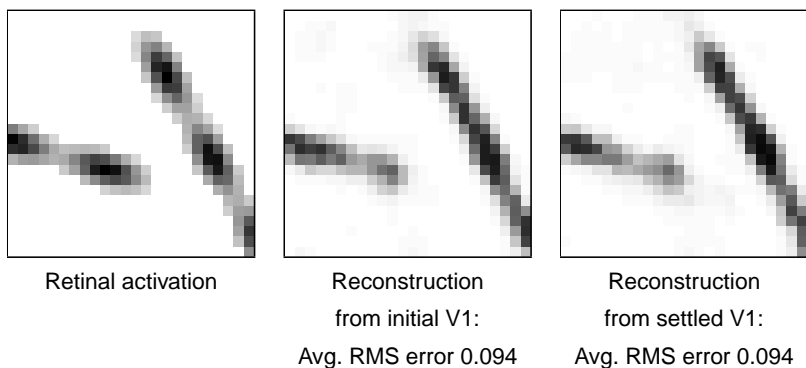

- Reconstruct the input from V1 activity
- Nonlinear: train a backprop net to map back
- → No information lost

Does LISSOM Form a Sparse Code?

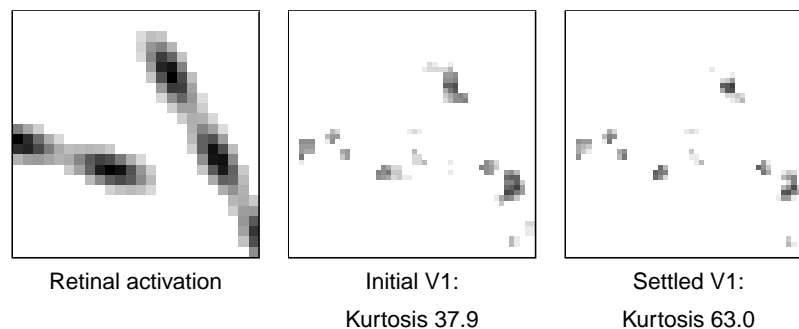

- Self-organize a LISSOM map
- Measure kurtosis of the response
- → The settled response is sparser

Is Self-Organization Necessary?

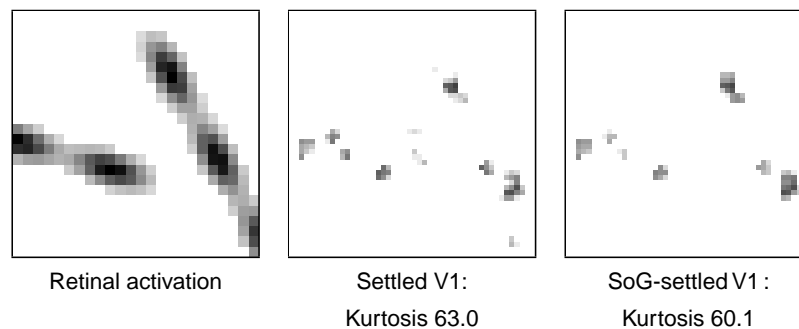

- Isotropic (Sum-of-Gaussians; SoG) lateral connections instead
- Can be adjusted to match kurtosis
- → Sparse code can be formed

Is Self-Organization Necessary?

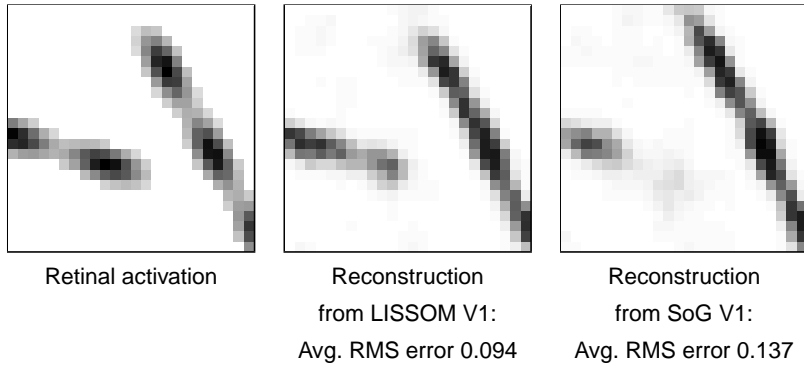

- Reconstruction no longer works!
- Information reduced, not just redundancy
- → Self-organization is necessary
- → Forms a sparse, redundancy-reduced code

Newborn Face Preferences

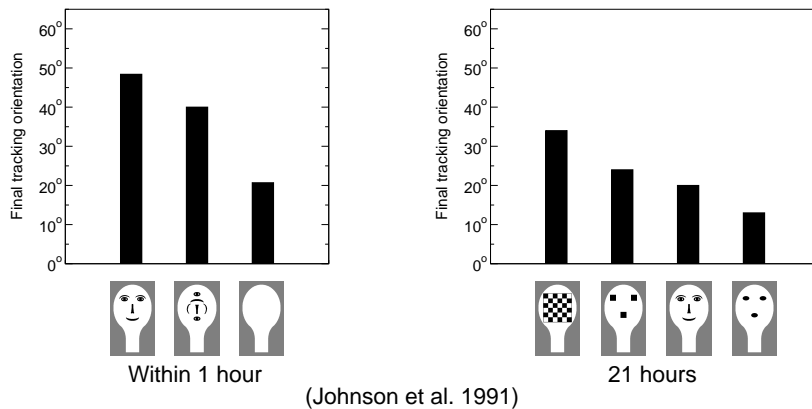

- Significant preference for face-like schematics
- Genome too small to specify connectivity, behavior
- Three-dot patterns strongest; why?

Nature vs. Nurture



- Development through input-driven self-organization
- But some order appears innate
 - E.g. orientation maps
 - E.g. newborn face preferences

Retinal Waves

(1 mm × 1 mm in ferret retina; Feller et al. 1996)

- Traveling waves in the retina before birth
- Could serve as input for self-organization

PGO Waves



(Marks et al. 1995)

- Ponto-geniculo-occipital waves
- Shape unknown, but activates V1
- Could introduce the three-dot bias

HLISSOM Model

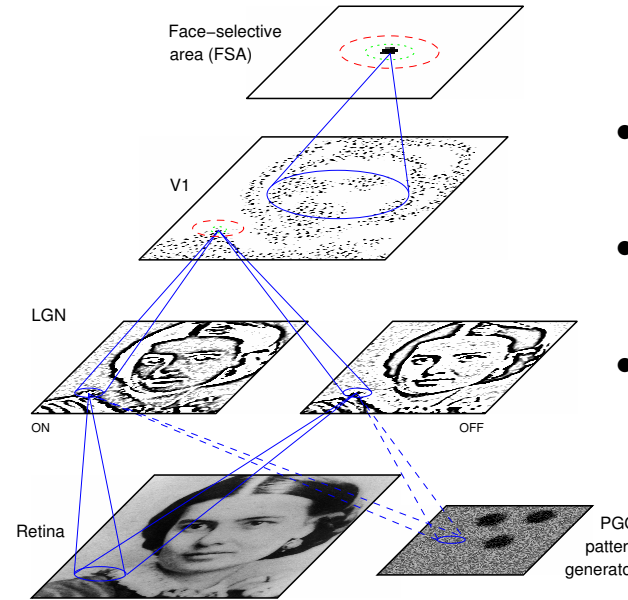

- Include PGO & FSA sheets
- Three-dot input patterns in PGO
- Study prenatal and postnatal self-organization

Newborn LISSOM Face Preferences

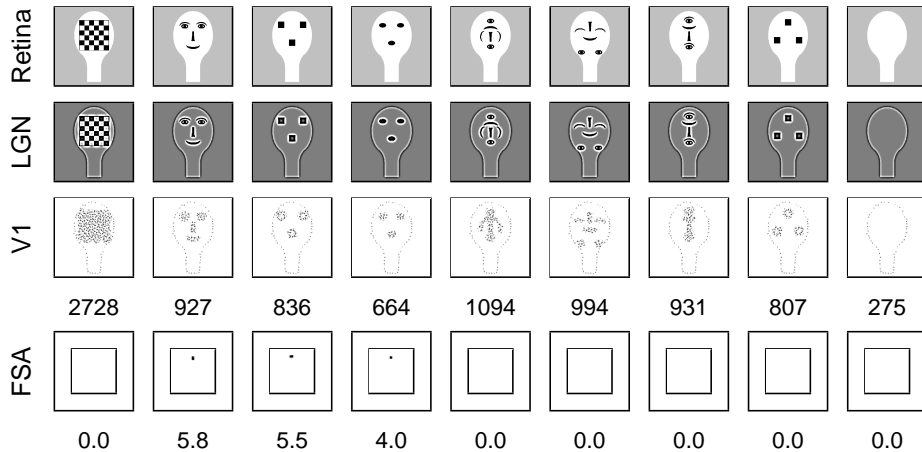

- Matches newborn preferences in every known case

Newborn LISSOM Face Preferences (2)

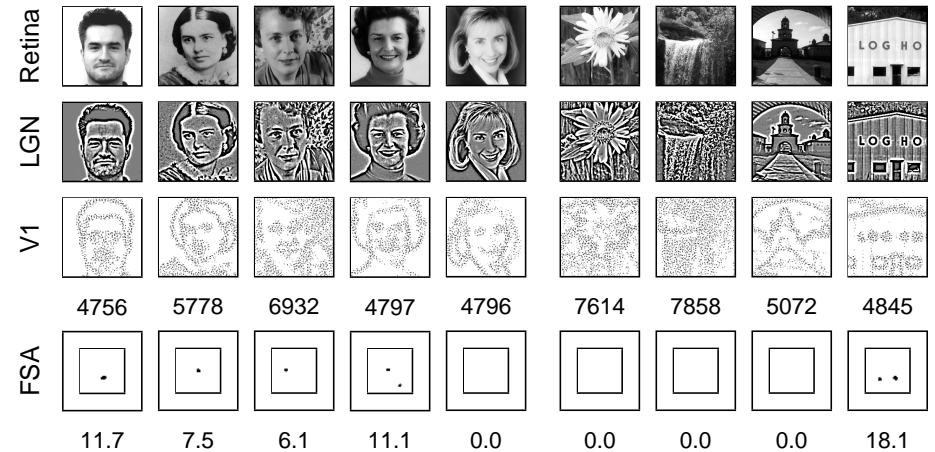

- Prefers top-lit faces; not objects
- Images not tested on infants

Effect of Pattern Types

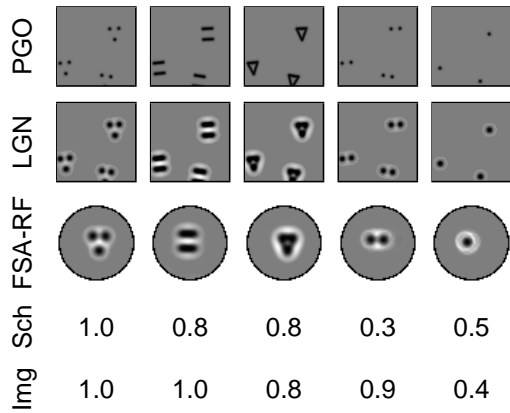

- Three dots not the only possible pattern
- Not all patterns work

Pattern Generation Conclusions

- How are nature and nurture combined?
 - Through internal pattern generation
- Predictions
 - Types of internal patterns
 - Postnatal decline of preferences
 - Holistic perception of the face develops
 - Mother preferences develop

Perceptual Grouping

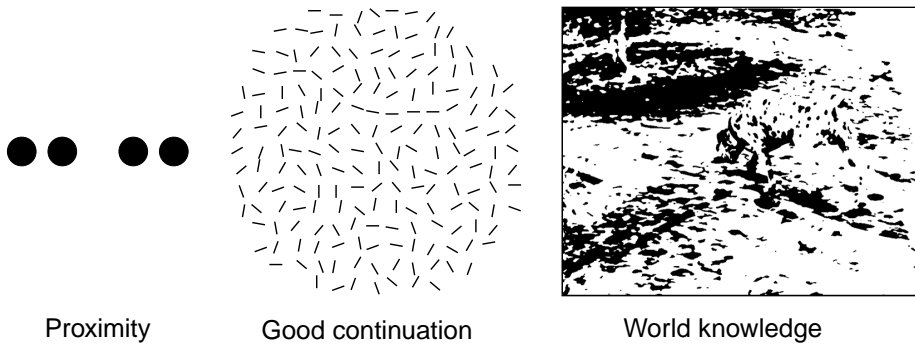

- Perceiving whole objects
- Low-level based on “Gestalt” principles
- Mediated by lateral connections in V1?

PGLISSOM Model

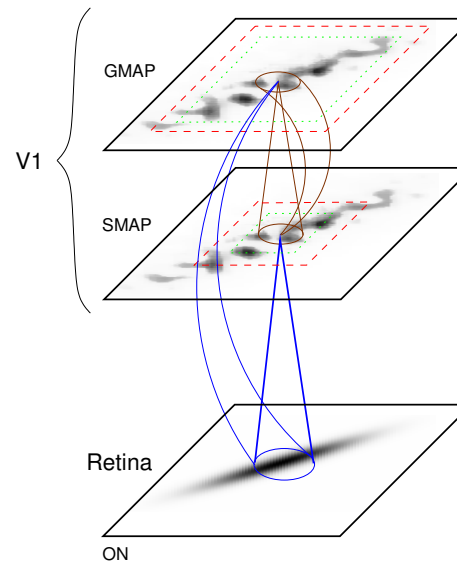

- Self-organization needs long-range inhibition
- Grouping needs long-range excitation
- → 2-layer model of the column

Leaky Integrator Neuron

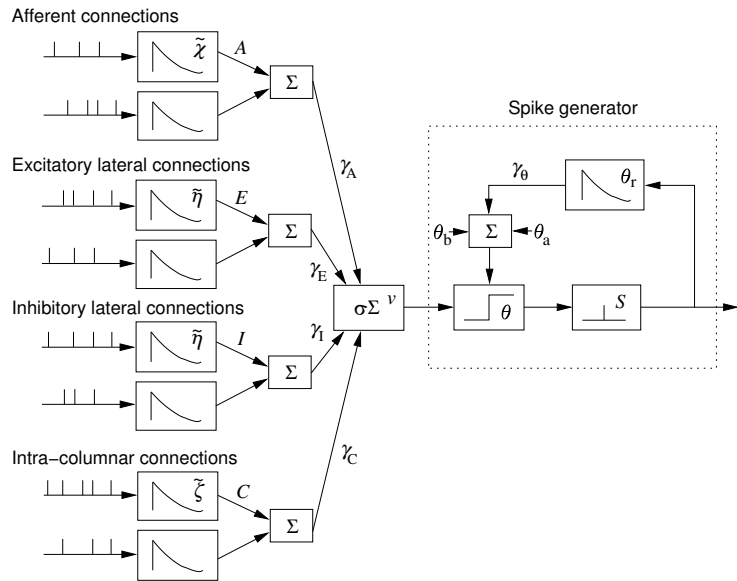

- Binding and segmentation by synchronization
- Need spiking neurons

Self-Organized Lateral Connections

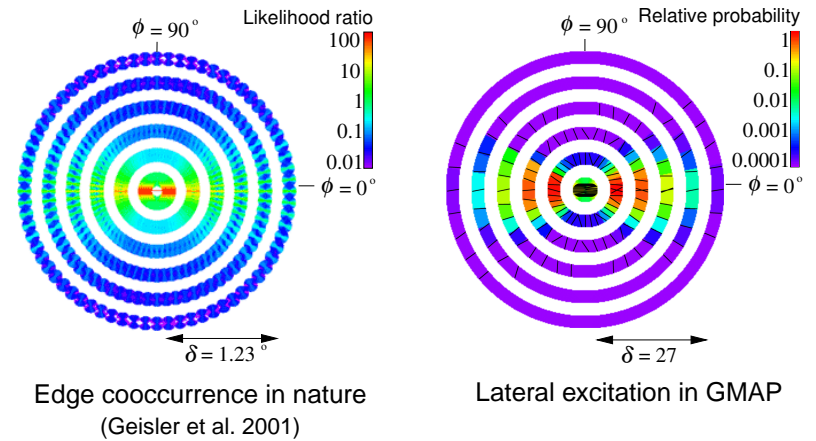

- PGLISSOM self-organizes like LISSOM
- Lateral connections match visual environment

Contour Integration Process

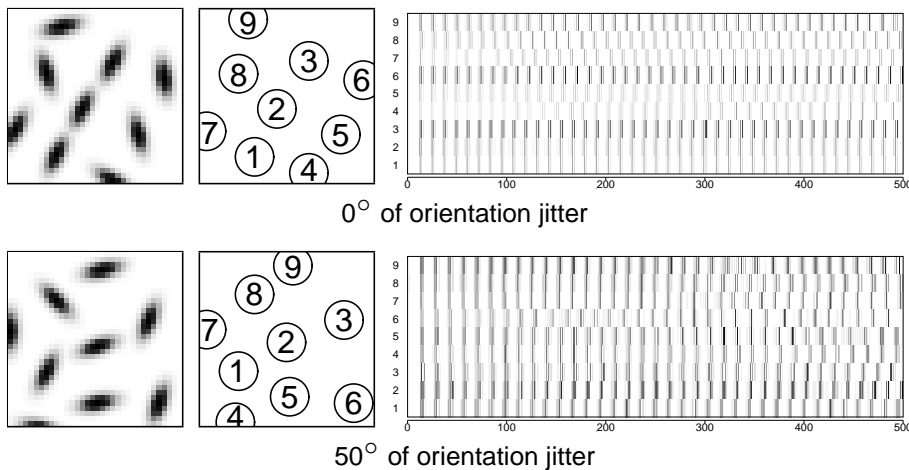

- Synchronizes continuous contours
- Depends on how "good" the contour is

PGLISSOM vs. Human Performance

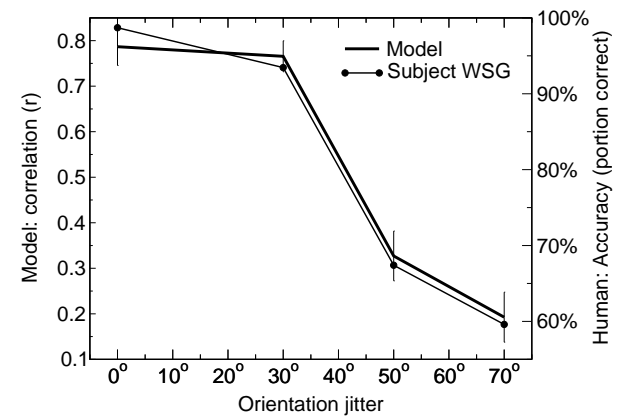

- Depends on jitter like human performance

Contour Segmentation

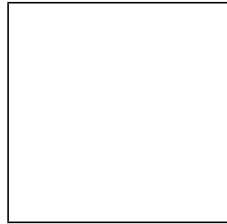
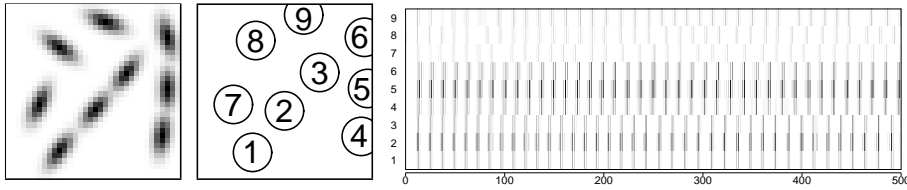

- Multiple contours by alternating
- Upto 5-9 contours

Contour Completion

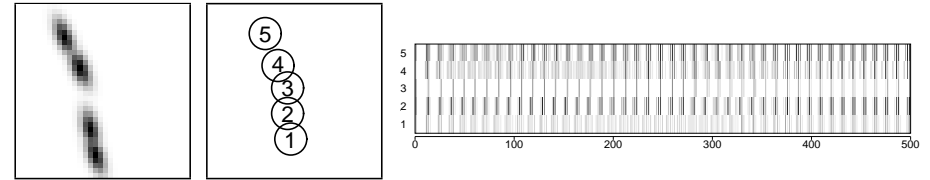

- Filling in gaps
- Basis for edge-induced illusory contours?

Illusory Contours

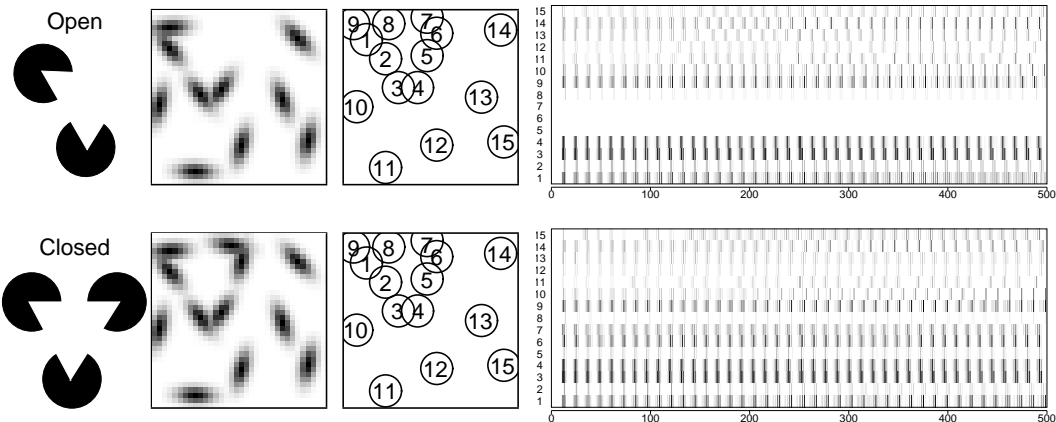

- Kanizsa: proximity & continuation
- Closed contours easier
- Matches human performance

Perceptual Grouping Conclusions

- How does the structure support functions like grouping?
 - Synchronization mediated by self-organized lateral connections
- Predictions:
 - Effect of activation decay, noise, refractory period on synchronization
 - Image statistics → lateral connectivity → performance
 - Frequency, curvature, etc. differ across visual fields
 - Performance differs in fovea vs. periphery, upper vs. lower hemifield

Future Work

- Self-organization
 - Color, frequency, disparity
 - Hierarchy, feedback, multimodal integration
- Development
 - Characterizing internal patterns
 - Constructing complex systems
- Grouping
 - Verify synchronization hypothesis with TMS
 - Line-end-induced illusions in V2?

Topographica

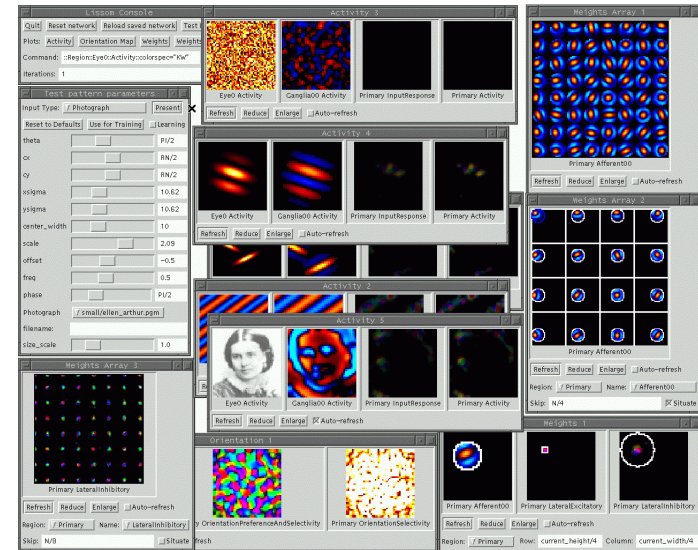

- General simulator for cortical maps (v0.8.2 Feb 2006)

Conclusion

- Wealth of data + powerful computing available
- Neuroscience research in vitro, in vivo, *in silico*
- Computational theory of the visual cortex
 - Continuously adapting self-organizing system
 - Shaped by internal and external input
 - Lateral connections play a major role
- Exciting possibilities for future work

Further Details

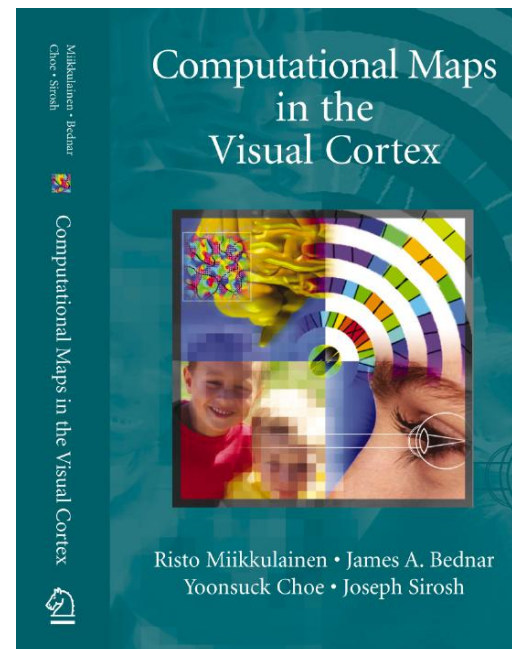

(Springer, 2005)

Demos, software, etc.:
www.computationalmaps.org